

Ø 16-110 mm



SYSTEM **KAN-therm**

PP

High quality  
at affordable price

EN 2018



TECHNOLOGY OF SUCCESS



ISO 9001



## About KAN

### Innovative water and heating solutions

KAN was established in 1990 and has been implementing state of the art technologies in heating and water distribution solutions ever since.

KAN is a European recognized leader and supplier of state of the art KAN-therm solutions and installations intended for indoor hot and cold tap water installations, central heating and floor heating installations, as well as fire extinguishing and technological installations. Since the beginning of its activity, KAN has been building its leading position on such values as professionalism, innovativeness, quality and development. Today, the company employs over 600 people, a great part of which are specialist engineers responsible for ensuring continuous development of the KAN-therm system, all technological processes applied and customerservice. The qualifications and commitment of our personnel guarantees the highest quality of products manufactured in KAN factories.

Distribution of the KAN-therm system is performed through a network of commercial partners all over Poland, Germany, Russia, Ukraine, Belarus, Hungary, Ireland, the Czech Republic, Slovakia, Romania, in Scandinavia and in the Baltic States. Our expansion and dynamic development has proven so effective that KAN-therm labeled products are exported to 60 countries, and our distribution network assumes Europe, a great part of Asia, and a part of Africa.

The KAN-therm system is an optimal, complete multipurpose installation system consisting of state of the art, mutually complementary technical solutions for pipe water distribution installations, heating installations, as well as technological and fire extinguishing installations. It is the materialization of a vision of a universal system, the fruit of extensive experience, the passion of KAN's constructors, as well as strict quality control of our materials and final products.



**SYSTEM KAN-therm**  
- special award:  
**Pearl of the highest quality**  
and:  
**Golden Quality International Medal**  
2015, 2014 i 2013.

TECHNOLOGY OF SUCCESS



## Table of contents

3	KAN-therm PP System
4	Advantages
5	Application
6	Pipes
7	Fittings
7	Tools
8	Assembly
9	Additional information
11	Past projects

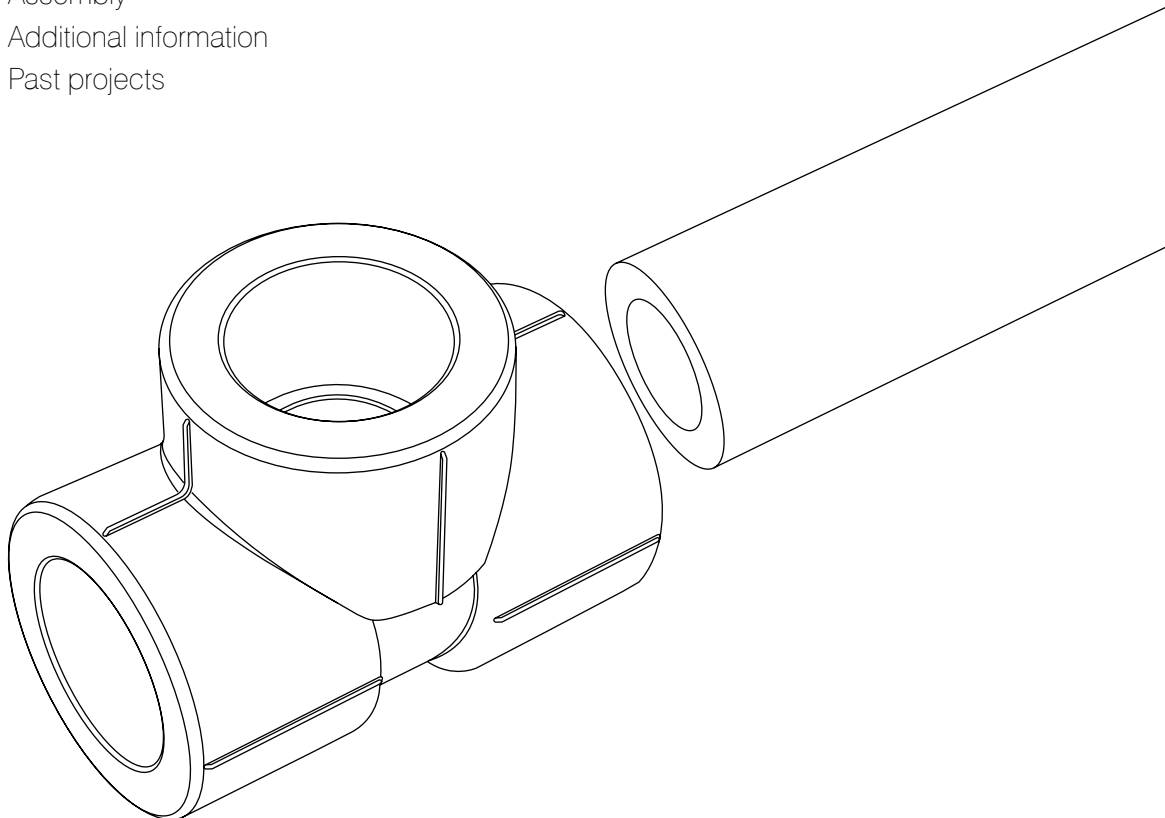

## SYSTEM **KAN-therm**

# PP

**KAN-therm PP is a complete installation system consisting of pipes and fittings made of polypropylene PP-R (type 3), a thermoplastic material, and offering a range of diameters of 16-110 mm.**

Joining system elements is performed using the coupling welding technique (thermal polyfusion) and electric welders. This welding technique creates continually identical joints in terms of quality and therefore guarantees exceptional tightness and mechanic durability of the installation.

The system is designed for indoor water supply installations (hot and cold tap water), heating installations and technological installations in the industry.

Due to its properties and the joining method, the system is ideal for multi-family housing buildings, with various types of renovations or complete replacements of old hot and cold tap water installations.

## Advantages

- **certified quality**  
Production of system elements takes place under strict supervision of the Quality Control section in KAN's modern production plants with the ISO 9001 quality management system implemented. Before introducing on the market all elements of the system undergo strict tests in KAN's state of the art laboratory. Pipes and fittings undergo a simulation of 50-years' installation use.
- **highest quality, environmentally friendly material**  
Materials used to produce system elements are proven in terms of physiological and microbiological inertness in potable water installations, plus they do not alter the chemical composition of potable water (as confirmed by a certificate of the Polish Hygiene Institute), and are therefore neutral for the natural environment and human health.
- **experience**  
KAN is a recognized Polish and European leader and supplier of pipe installations, as proven by 20 years of delivering pipe installation elements for central heating and water distribution applications.
- **one manufacturer of pipes and fittings, applying state of the art technologies**  
KAN-therm PP pipes and fittings come from one manufacturer, and the granulated mass used in their production is identical, which has essential and beneficial impact on the quality and durability of joints.
- **perfect for replacing old installations**  
Thanks to its wide range and comprehensive offer of elements, high durability, attractive price and technical and functional properties, the KAN-therm PP system is particularly recommended for modernizations of old water distribution and heating installations.
- **on-plaster mount**  
Thanks to increased rigidity of pipes made of polypropylene, it is possible to perform on-plaster installations, maintaining their esthetic appearance and functionality.
- **high thermal resistance**  
Thanks to considerable polypropylene resistance to various types of chemicals, it is possible to apply the system in various industrial and technological installations (after consultation with KAN's Technical Department).



## Application

The system is designed for constructing complete (risers and horizontal feeding pipes), indoor-use heating installations as well as hot and cold tap water installations in multi-family housing and public buildings.

The system is particularly recommended for replacing old, corroded, steel, hot and cold tap water installations and old compressed air installations.

Low thermal elongation of pipes, thanks to the application of an aluminum layer in the structure of Stabi Al piper or a fiberglass layer in the structure of PP Glass pipes makes the system an ideal solution for on-plaster heating installations and cold or hot tap water installations, e.g. when renovating old, historical buildings which do not offer the possibility of placing the installation in structural partitions

Due to high chemical resistance of KAN-therm PP pipes and fittings, it is possible to apply the system in various non-standard technological installations – after consultation with KAN's Technical Department.



- hot and cold tap water installations
- central heating installations
- compressed air installations
- balneological installations
- installations in agriculture and horticulture
- industrial pipelines
- shipyard installations





# Pipes

## Universal applications

An extensive offer of polypropylene pipes will allow you to apply KAN-therm PP System pipes in nearly all types of installations, beginning with central heating, through hot and cold tap water installations and compressed air installations, and ending with special installations designed to transport aggressive media and technological installations.

Various pipe structures in the KAN-therm PP range provide multiple possibilities in terms of assembly:

- **uniform PP pipes** which do not require any additional mechanic treatment (removal of Al foil) prior to sealing the joint. They are usually applied in installations with low or medium temperature of the medium transported, e.g. cold and hot tap water, compressed air or installations for transporting aggressive media:

PN 10/S5 (20–110mm)

PN 16/S3.2 (20–110mm)

PN 20/2.5 (16–110mm)

- **PP Stabi Pipes**, for which removing the layer of Al foil constituting an integral part of the pipe is essential for the assembly process to be performed correctly. Due to a low thermal elongation coefficient, PP Stabi pipes are recommended for constructing installations for transporting high-temperature medium, e.g. central heating installations.

PN 16 Stabi Al (20–75mm)

PN 20 Stabi Al (16–110mm)

- **PP Glass Pipes** are pipes, the structure of which combines the properties of Stabi pipes with the comfort of assembly of uniform pipes. Thanks to the application of a layer of fiberglass, PP Glass pipes do not require any additional mechanic treatment (removal of Al foil) prior to sealing the joint, plus they feature a low thermal elongation coefficient. PP Glass pipes are commonly used for constructing installations for transporting high-temperature medium, e.g. central heating installations.

PN 16 Glass (20 – 110mm), PN 20 Glass (20–110mm)



# Fittings

## Safety

Specially modified structure of KAN-therm PP System fittings eliminates excessive impact of the material in the pipe-fitting joint. This solution allowed us to minimize the risk of blocking the cross-section during assembly. Another important feature of fittings in the KAN-therm PP System is the absence of bottlenecks, which contributes to minimizing pressure loss in the entire installation.

1. Competitive fitting – No clear structural stopper (the possibility of excessive impact of material and cross-section bottleneck).

2. KAN-therm PP fitting – special structural stopper (limited material impact and no bottleneck effect).

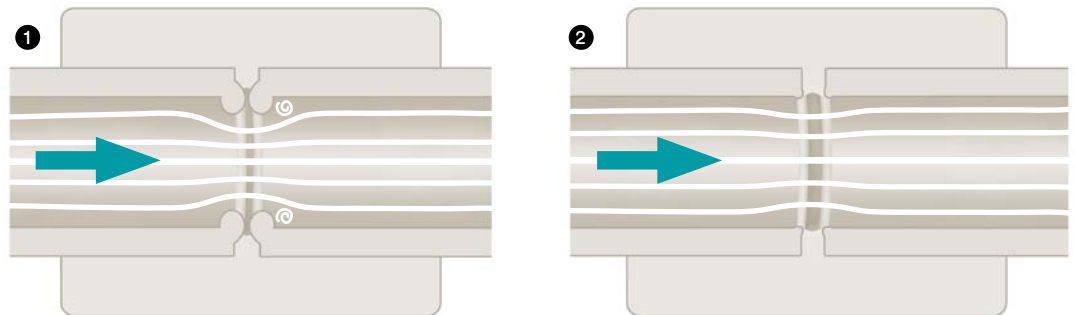

## Esthetic

Installations performed in the KAN-therm PP system offer an added esthetic quality, thanks to which they may be successfully applied in on- and sub-plaster installations.



# Tools

## Professionalism

Apart from pipes and fittings, KAN-therm offers a wide range of professional, advanced tools for safe and secure performance of element joints.

- **Tool sets with 800W and 1600W welders equipped with welding inserts for every pipe diameter**
- **Classic and rotary pipe cutters for diameters up to 110mm.**
- **Scrapers with exchangeable blades for removing Al foil in Stabi pipes.**

Correct pipe jointing has essential impact on undisturbed and long-term operation of the entire installation, and therefore all tools used for mounting KAN-therm PP pipes and fittings are tested according to strict standards in KAN's laboratory.



## Easy and quick assembly

Joining system elements is performed using the coupling welding technique (thermal polyfusion) and electric welders. This welding technique creates continually identical joints in terms of quality and therefore guarantees exceptional tightness and mechanic durability of the installation.

1. Pipe cutting using a pipe cutter.
2. Removing aluminum foil using a scraper (Stabi Al multilayer pipes).
3. Marking the welding depth.
4. Heating the pipe and the fitting.
5. Joining the elements.
6. Stabilizing and cooling the joint.

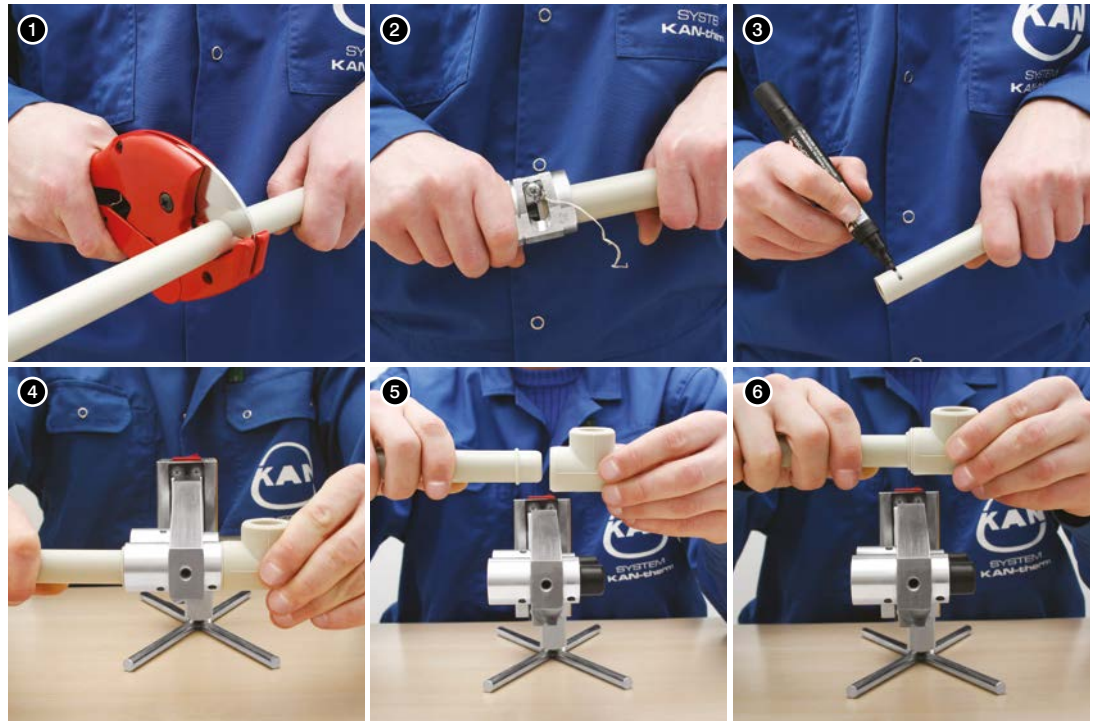

### WELDING PARAMETERS

External pipe diameter	Welding depth	Heating time	Binding time	Cooling time
[mm]	[mm]	[sec.]	[sec.]	[minutes]
16	13	5	4	2
20	14	5	4	2
25	15	7	4	2
32	16	8	6	4
40	18	12	6	4
50	20	18	6	4
63	24	24	8	6
75	26	30	10	8
90	29	40	10	8
110	32.5	50	10	8

The heating time for thin-wall pipes (PN 10) is reduced by half (the fitting heating time remains unchanged).

With ambient temperature below +5°C, the heating time should be increased by 50%.



## Highest quality guaranteed

The quality of pipes and fittings manufactured by KAN is controlled in the company's own, perfectly equipped research & development laboratory, and the results obtained are honored by leading European bodies, such as KIWA, KOMO, DVGW, SKZ, CSTB and many more. State of the art, professional instrumentation allows for performing continuous monitoring of production processes and random testing of the technical parameters of KAN-therm PP pipes and fittings, which are also controlled by external laboratories, which also allows us to maintain the quality of our products at the highest global level.

## DVGW Compliance

Due to high quality and solid construction, the KAN-therm PP System was positively certified according to DVGW requirements.



## ISO 9001

As the entire activity of KAN, the production of KAN-therm PP System elements is performed under the supervision of the ISO 9001 quality management system and is certified by the Lloyd's Register Quality Assurance Limited. Cyclic external and internal audits carried out according to international standards ensure that the ISO 9001 Quality Management System is continually improved.

State of the art instruments included in the equipment of KAN's laboratory allow for controlling the condition of devices and the quality of elements at every stage of their production, from raw materials to finished products.

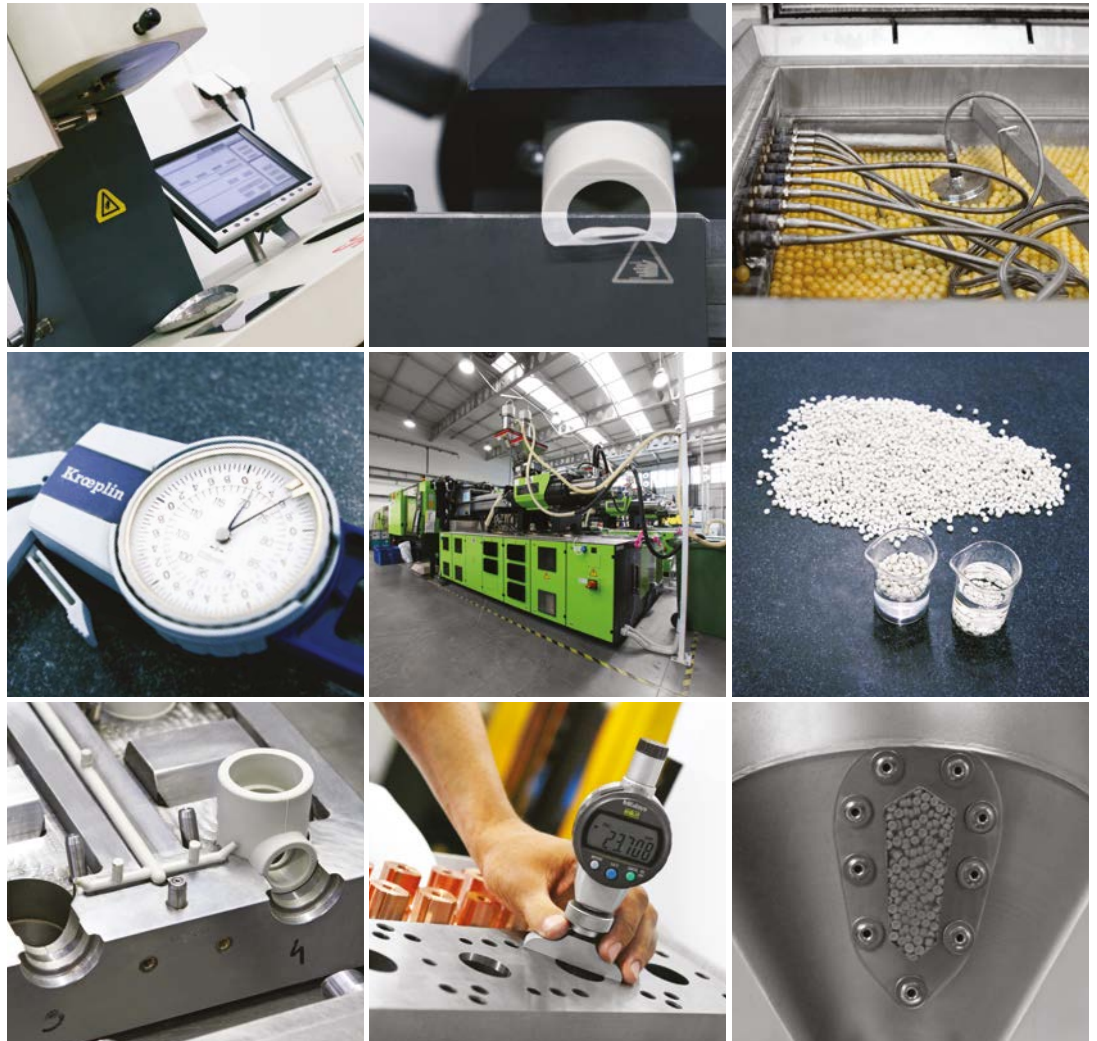



## The Natural Environment



KAN-therm PP pipes and fittings are produced in modern production plants designed in consideration of the protection of the natural environment, located in one of European greenest regions, in the vicinity of major nature reservations listed in the UNESCO register. The elements are manufactured applying technologies minimizing the consumption of electricity and raw materials. No additives containing toxic or harmful substances are used in the production of pipes and fittings.

## Ecology

Only highest quality PP-R (polypropylene-random-copolymer) granulated material is used to produce KAN-therm PP System pipes and fittings. PP-R is produced according to the guidelines of the ISO 14001:2004 environmental standard.

PP-R does not contain any toxic substances to the natural environment, such as chlorine or heavy metals. Combustion products are carbon dioxide and steam only. No toxic gasses, such as hydrogen chloride or dioxins are produced in combustion, which makes KAN-therm installations safe, also in fire incidents.

## Hygiene

KAN-therm pipes and fittings are used for transporting the most important food product – potable water. Thanks to the application of high quality raw materials, a modern, clean production technology and strict quality control, all KAN-therm PP pipes and fittings comply with all, even the strictest hygiene standards and requirements regarding the quality of water transported.

KAN-therm System products are certified by world's most renowned bodies.





## Past projects

All our past projects performed in various sectors of the construction industry are the ideal confirmation of the highest quality of our products.

Although you can't see them at first glance, KAN-therm installations have been successfully working in major housing estates, public buildings, single-family buildings, sports and recreation facilities, as well as industrial plants and factories for more than 20 years.

KAN-therm is the perfect solution for new investments and renovated buildings, which is why you can also encounter it in historical and sacral buildings.

1. Sky Tower - Wrocław, Poland.

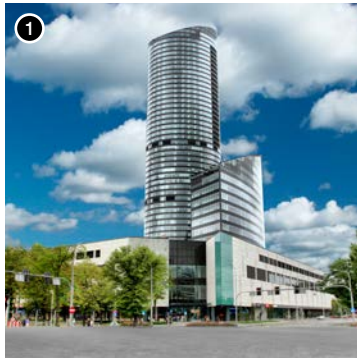

2. Stadium - Białystok, Poland.



3. Pomeranian Dukes' Castle - Szczecin, Poland.



4. Hilton Garden Inn Kraków Air Port - Cracow Poland.



5. Railway Station - Wrocław, Poland.



6. An office building „Tensor” - Gdańsk, Poland.



7. Ukrainian Theater – Odessa, Ukraine.



8. “Ukraine” Hotel – Rivne, Ukraine.



9. Shangri-La Traders Hotel – Doha, Qatar.

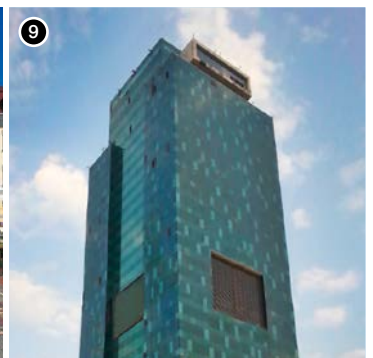

10. Entertainment-recreational center – Voronezh, Russia.





















11. Housing building – Moscow, Russia.



## SYSTEM **KAN-therm**

Optimal, complete multipurpose installation system consisting of state of the art, mutually complementary technical solutions for pipe water distribution installations, heating installations, as well as technological and fire extinguishing installations.

It is the materialization of a vision of a universal system, the fruit of extensive experience, the passion of KAN's constructors, strict quality control of our materials and final products, and vast knowledge of the market of installations to meet the requirements of energy efficient, sustainable construction.

	Push Platinum	
	Push	
	Press LBP	
	PP	
	Steel	
	Inox	
	Sprinkler	
	Surface heating and automation	
	Football Stadium installations	
	Cabinets and manifolds	



**KAN** Sp. z o.o.  
ul. Zdrojowa 51, 16-001 Białystok-Kleosin  
tel. +48 85 74 99 200, fax +48 85 74 99 201  
e-mail: [kan@kan-therm.com](mailto:kan@kan-therm.com)