

Ø 16-63 mm



SYSTEM **KAN-therm**

Press LBP

Innovativeness and uniqueness  
- One system, six functions

EN 19/09



TECHNOLOGY OF SUCCESS



ISO 9001



## About KAN

### Innovative water and heating solutions

KAN was established in 1990 and has been implementing state of the art technologies in heating and water distribution solutions ever since.

KAN is a European recognized leader and supplier of state of the art KAN-therm solutions and installations intended for indoor hot and cold tap water installations, central heating and floor heating installations, as well as fire extinguishing and technological installations. Since the beginning of its activity, KAN has been building its leading position on such values as professionalism, innovativeness, quality and development. Today, the company employs over 800 people, a great part of which are specialist engineers responsible for ensuring continuous development of the KAN-therm system, all technological processes applied and customerservice. The qualifications and commitment of our personnel guarantees the highest quality of products manufactured in KAN factories.

Distribution of the KAN-therm system is performed through a network of commercial partners all over Poland, Germany, Russia, Ukraine, Belarus, Hungary, Ireland, the Czech Republic, Slovakia, Romania, in Scandinavia and in the Baltic States. Our expansion and dynamic development has proven so effective that KAN-therm labeled products are exported to 60 countries, and our distribution network assumes Europe, a great part of Asia, and a part of Africa.

The KAN-therm system is an optimal, complete multipurpose installation system consisting of state of the art, mutually complementary technical solutions for pipe water distribution installations, heating installations, as well as technological and fire extinguishing installations. It is the materialization of a vision of a universal system, the fruit of extensive experience, the passion of KAN's constructors, as well as strict quality control of our materials and final products.

TECHNOLOGY OF SUCCESS



## Table of contents

3	System KAN-therm Press LBP
4	Advantages
5	Application
6	Pipes
7	Press LBP Fittings
11	Tools
13	Installation
14	Awards and certificates
14	Quality
15	Implementations

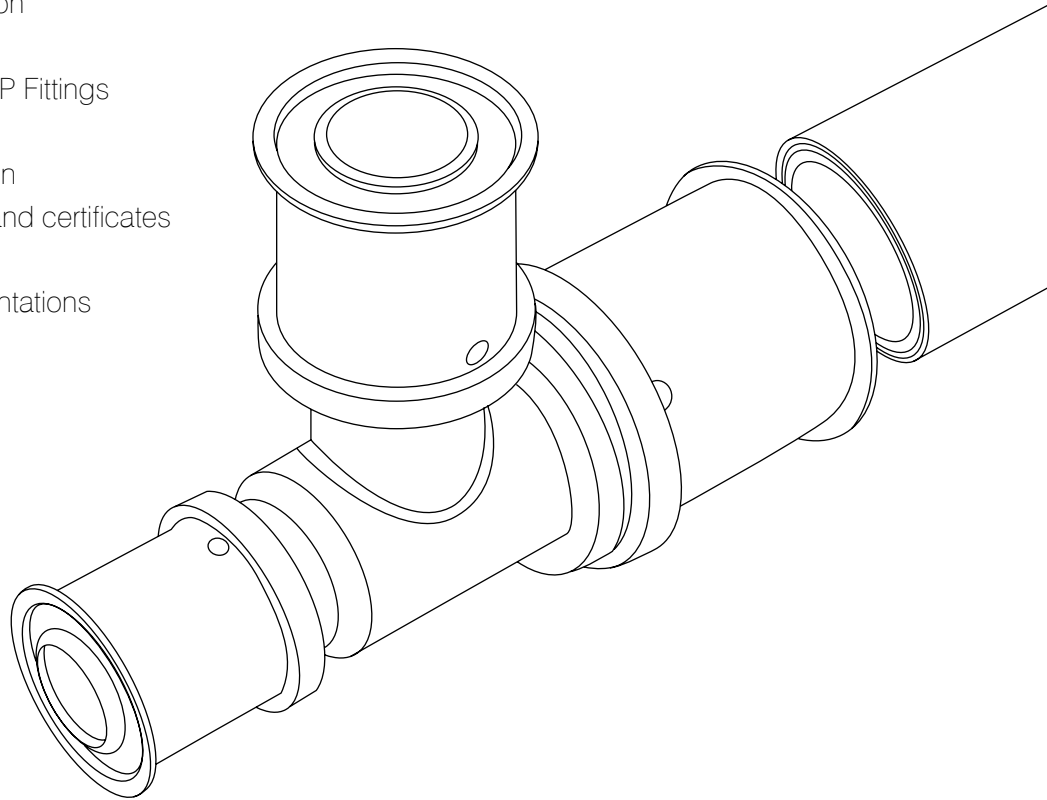

## SYSTEM **KAN-therm**

# Press LBP

**KAN-therm Press is a modern, complete installation system consisting of composite polyethylene pipes with aluminum layer and plastic PPSU or brass fittings with a diameter range between 16–63 mm.**

**All fittings with 16–40 mm diameters have a new, unique "LBP" design, combining a number of innovative solutions to improve comfort and safety of installation and to ensure proper connections.**

**This ensures that all components of KAN-therm Press LBP make up the only unique installation system on the market.**

The system is designed for indoor plumbing (hot and cold water) system, central heating or cooling systems, technological heat and industrial installations (e.g. compressed air). The Press connection technology is based on pressing a steel ring on the pipe mounted onto the fitting nozzle. The nozzle is fitted with o-ring seals that provide tight and trouble-free operation of the system.

KAN-therm Press/Press LBP is ideal for the construction of new and renovation of existing indoor central heating systems, radiant heating and cooling (floors, walls) and hot and cold water systems. Due to the material characteristics and the range of diameters, the system is used for piping systems in multi-family housing, single-family homes and public facilities.

## Advantages

Modern and unique in its structure, KAN-therm Press LBP is the only technical solution on the market that offers 6 functions in one setup:

1. <b>LBP System</b>	Unpressed connection signaling function (fittings with 16–32 mm diameters)	<input checked="" type="checkbox"/>
2. <b>Versatility</b>	Possibility to use clamping jaws with two clamping profiles: U and TH	<input checked="" type="checkbox"/>
3. <b>Safety</b>	Special-design steel clamping sleeve forces automatic correct placement of the clamping jaw.	<input checked="" type="checkbox"/>
4. <b>Comfort</b>	Safe and easy installation by eliminating the need for calibration and chamfering.	<input checked="" type="checkbox"/>
5. <b>Compatibility</b>	Possibility to use composite PE-RT/Al/PE-RT, PE-X/Al/PE-X pipes and homogenous PE-Xc and PE-RT pipes.	<input checked="" type="checkbox"/>
6. <b>Identification</b>	Easy identification of the fitting's diameter thanks to the plastic colored rings.	<input checked="" type="checkbox"/>

More info at p. 7 – 10.

Moreover, KAN-therm Press LBP means:

- **50-years service life** – all components are tested at the highly specialized KAN research laboratory for 50-year operation of the system.
- **Versatile application** – multilayer pipes included in KAN-therm Press System can be successfully used in heating installation and water systems, as well as in all types of radiant heating and cooling systems. Following consultations with KAN, the system may also be used in a variety of industrial process systems, such as e.g. compressed air.
- **Reduced coefficient of thermal expansion** – multilayer pipes thanks to aluminum layer have an 8 times lower coefficient of thermal expansion compared to solid plastic pipes.
- **Plasticity of pipes** – due to the lack of shape memory, multilayer pipes retain the desired shape, which greatly facilitates the installation of pipeline routes.
- **Health and ecology** – materials used to manufacture the system components are physiologically and microbiologically neutral in drinking water installations; materials are friendly to the environment and human health – approved by Polish National Health Institute.
- **Flush installation** – possibility to conceal the connections in floors and walls (under plaster).

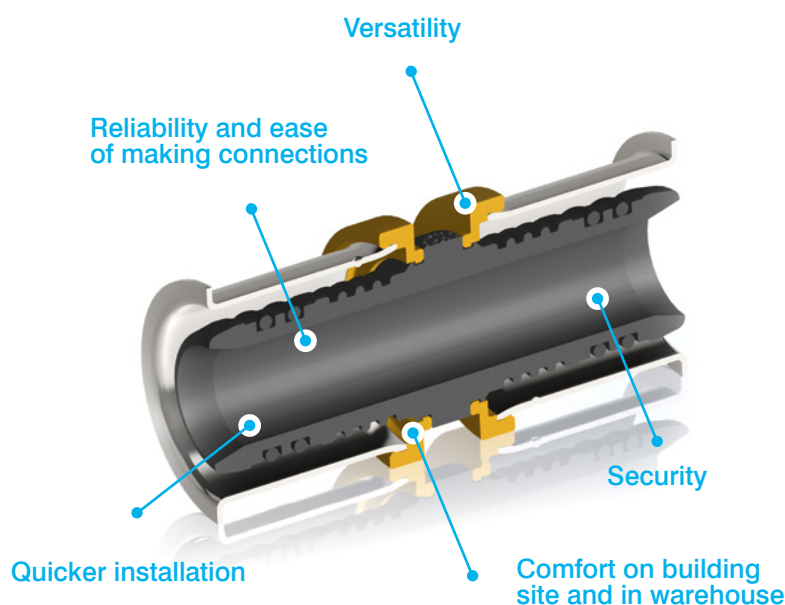

# Application



KAN-therm Press/Press LBP is designed for indoor plumbing systems, central heating and cooling systems, all kinds of radiant heating and cooling (floors and walls), heating and cooling systems for outdoor spaces (playing fields and ice rinks) and various industrial systems (e.g. compressed air) – after consultation with KAN.

System KAN-therm Press/Press LBP				
Type of pipe	PE-RT/Al/PE-RT, PE-X/Al/PE-X		PE-RT and PE-Xc	
Parameters	Heating systems		Heating systems	Water systems
$T_{working}$ [°C]	80	60	80	60
$T_{max}$ [°C]	90	80	90	80
$T_{ma}$ [°C]	100	100	100	100
Operating pressure [bar]	10	10	6	6

System components can be successfully used in single- and multi-family housing, public buildings (schools, hotels, sports facilities).

Due to the low coefficient of thermal expansion, surface-mounted systems have minimized risk of pipes slacking between the brackets; the system is ideal for the renovation of historic buildings.



# Pipes

## Wide offer range and compatibility

Due to the new design of fittings in KAN-therm Press LBP, the offer includes two constructions of pipes.

- **multilayer polyethylene pipes with aluminum**
- **homogenous polyethylene pipes PE-RT and PE-Xc**

**Homogenous polyethylene pipes** in KAN-therm Press/Press LBP System come in two material varieties, with different types of base inner and outer layer – PE-RT/Al/PE-RT pipes (diameter range of 14–40 mm) and PE-X/Al/PE-X pipes (50–63 mm).

Multilayer pipes consist of the following layers:

- **inner layer** (core tube) made of PE-RT polyethylene with improved thermal resistance or PE-X cross-linked polyethylene,
- **mid-layer** in the form of aluminum tape, butt-welded with ultrasound,
- **external layer (coating)** made of PE-RT polyethylene with improved thermal resistance or PE-X cross-linked polyethylene.

1. Structure of a composite pipe.

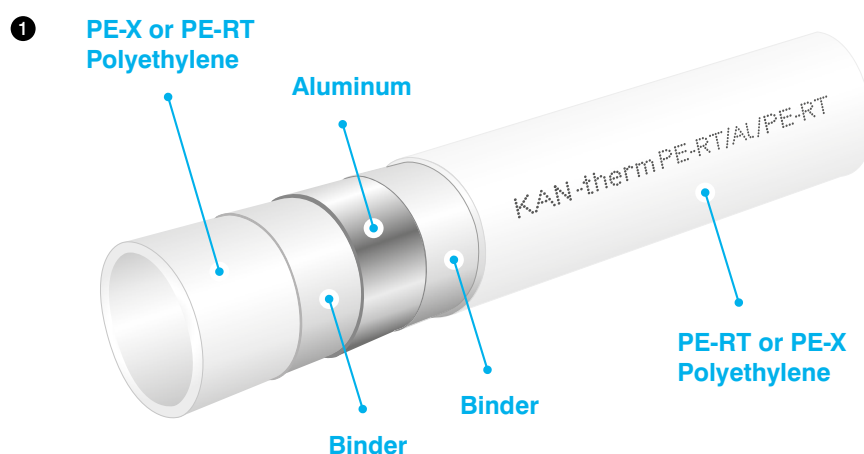

The aluminum layer provides a diffusion barrier and makes the pipes 8 times less prone to thermal expansion than homogenous polyethylene pipes.

Due to butt welding of the Al tape, the pipes have perfectly round cross-sections.

The KAN-therm Press/Press LBP multilayer pipes have the same nominal pressure rate throughout their entire diameter range (Multi Universal):

Application (classes in accordance with ISO 10508)	Dimension	Type of pipes	Connection system	
			Press	Twist-lock
Cold water, Hot water [Application class 1(2)] $T_{op}/T_{max} = 60(70)/80$ °C, $P_{op} = 10$ bar Floor heating, low-temperature radiator heating [Application class 4] $T_{op}/T_{max} = 60/70$ °C, $P_{op} = 10$ bar Radiator heating [Application class 5] $T_{op}/T_{max} = 80/90$ °C, $P_{rob} = 10$ bar	14 × 2,0	PE-RT/Al/PE-RT Multi Universal	—	+
	16 × 2,0		+	+
	20 × 2,0		+	+
	25 × 2,5		+	+
	26 × 3,0		+	+
	32 × 3,0		+	—
40 × 3,5	+	—		
For all classes $T_{maj} = 100$ °C	50 × 4,0	PE-X/Al/PE-X	+	—
	63 × 4,5	Multi Universal	+	—

**Homogenous polyethylene pipes** are available in two material variants, PE-RT (type II) in diameter range of 16×2 and 20×2, and PE-Xc in diameter range of 16×2, 20×2.

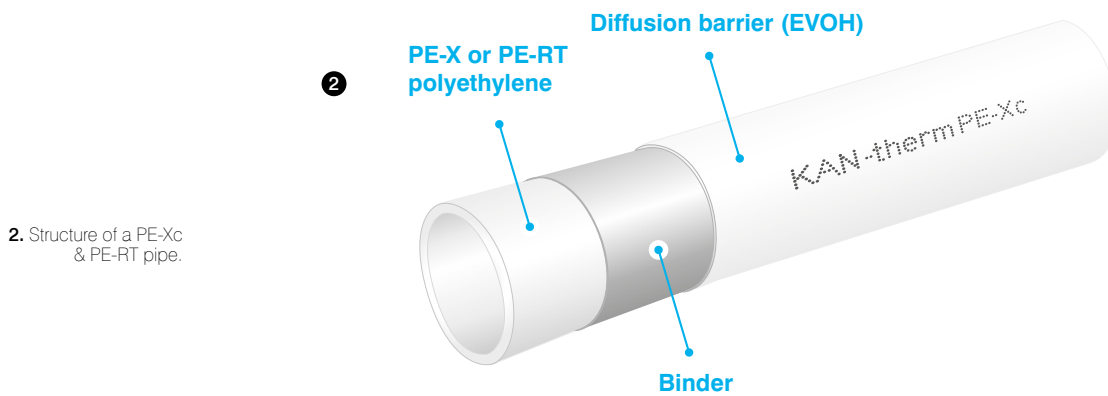

The KAN-therm Press LBP homogenous polyethylene pipes can only be used in systems with working pressure up to 6 bar.

Application (classes in accordance with ISO 10508)	Dimension	Type of pipes
Low-temperature radiator heating [Application class 4] $T_{op}/T_{max} = 60/70\text{ °C}$ , $P_{op} = 6\text{ bar}$	16 × 2,0 20 × 2,0	PE-Xc
Radiator heating [Application class 5] $T_{op}/T_{cp} = 80/90\text{ °C}$ , $P_{op} = 6\text{ bar}$	16 × 2,0 20 × 2,0	PE-RT

**NOTE: PE-RT and PE-Xc pipes can only cooperate with KAN-therm Press LBP fittings and pipe joints for those types of pipes.**

## Press LBP Fittings

### 6in1 – many functions in one setup

All fittings in the diameter range between 16–40 mm have a new, unique design Press LBP that provides a number of additional features:

- LBP System\*** (Leak **B**efore **P**ress) with this function, unclamped connections already start leaking during filling installation with water (no need to generate pressure) – in accordance with the guidelines of the DVGW.

This allows for quick and easy location of unclamped joints, even in very difficult construction conditions.

\* Fittings of 40 mm in diameter do not have the function of leakage control.



## 2. Versatility

The new design of Press LBP fittings allows to make connections using jaws with the two most popular clamping profiles, "U" and "TH".



## 3. Safety

The special design of the steel sleeve prevents the improper alignment of the jaws on the fitting during the assembly process.

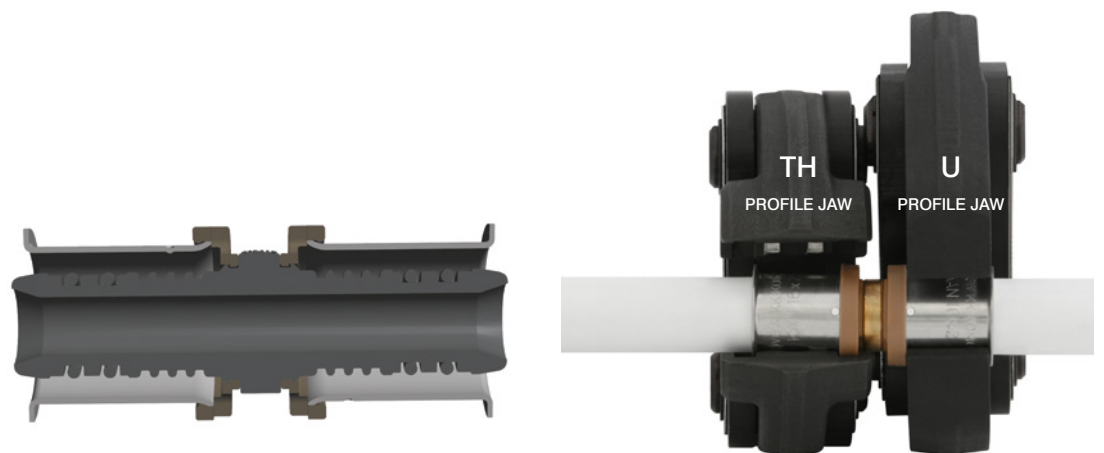

The "TH" profile jaw covers the plastic sleeve, the "U" is fixed between the plastic ring and the steel sleeve's flange.

This design solution eliminates assembly errors resulting from incorrect positioning of clamping jaws.



#### 4. Comfort

The end of the nozzle is designed in the form of a cone, which allows automatic calibration of a deformed pipe end while inserting it into the fitting.

In addition, the fittings body has deepened channels, to which the o-rings are attached. Therefore, seals are additionally protected against damage and against shifting while inserting the pipe into the fitting.

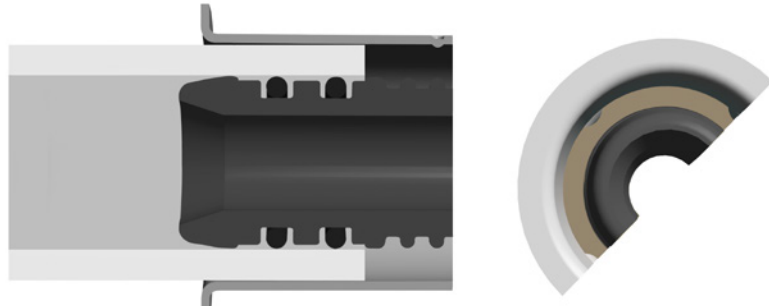

Due to this design of the fittings, there is no need for calibration and internal chamfering of the pipe, provided it has been properly cut (cut perpendicular with the use of sharp cutting tools).

#### 5. Compatibility

A new generation of Press LBP fittings features a special design of nozzles to allow the use of multilayer PE-RT/A/PE-RT pipes or homogenous PE-Xc, PE-RT pipes.



#### 6. Identification, corrosion resistance and durability

Each fitting with a diameter of 16–40 mm has a special plastic ring, whose color depends on the diameter of the connection. This makes it easier to identify fittings and speed up work at construction sites and in warehouses.

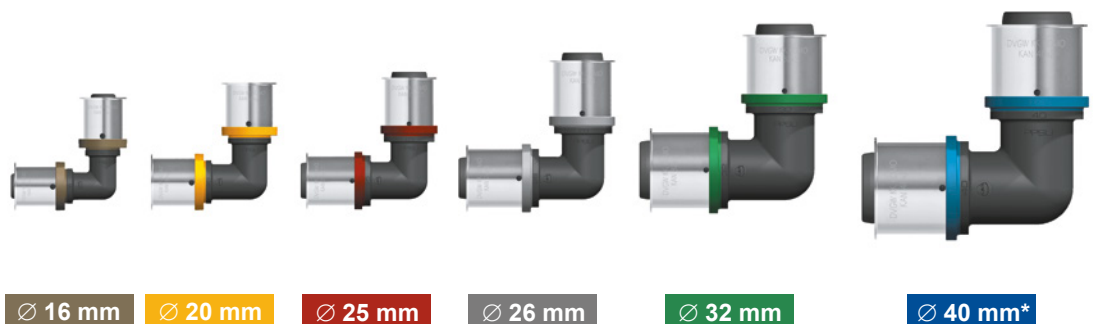

\* Fittings of 40 mm in diameter do not have the function of leakage control.

Fittings bodies made of PPSU are characterized by absolute neutrality to water, mechanical resistance close to that of non-ferrous metals and resistance to work in high temperatures.



Brass fittings are protected against corrosion by isolating the brass body from the aluminum layer inside the pipe with a colored plastic ring.

## Press Fittings

**Unique design with diameters 40, 50 and 63 mm**

All fittings with a nominal diameter of 40 mm (including 40 mm nozzles found in reducing fittings) have unique design features of Press LBP, except for the LBP function itself (LBP is not available in the design of nozzles with a diameter of 40 mm).

1. Example of a brass reducing tee with a 40 mm diameter Press nozzle.



All fittings with a nominal diameter of 50 and 63 mm (including 50 and 63 mm nozzles in reducer joints) have a traditional design and are marked as KAN-therm Press fittings. They are distinguished by the lack of color plastic rings, lack of the LBP function and a slightly different way of installation in terms of machining the ends of pipes and positioning of clamping jaws.

1. Body of a reducer joint.
2. Stainless steel clamping sleeve.
3. EPDM O-ring seal.
4. Rings retaining the steel sleeve on the body.
5. Inspection holes in steel sleeve.



## Tools

Installation of KAN-therm Press pipes and fittings can involve manual tools, power tools and battery tools.

All tools are available in sets or as individual components.

### REMS Tools:

- 1. Power Press ACC machine.
- 2. Aku Press machine.
- 3. Power Press SE machine.



- 4. Eco Press manual machine.
- 5. Press jaws „U or TH“ 14-40 mm.
- 6. Press jaws „TH“ 50-63 mm.



### NOVOPRESS Tools:

- 7. ACO 103 machine.
- 8. Press jaws PB1 „U or TH“ 14-32 mm.





- 9. EFP203 machine.
- 10. Press jaws PB2 „U or TH“ 14-40 mm.
- 11. 50 and 63 mm „TH“ Snap On collar.



- 12. ACO 203XL machine.
- 13. Press jaws PB2 „U or TH“ 14-63 mm.
- 14. Adapter ZB 203 50 and 63.



List of KAN-therm Press connectors taking into account the available diameters, clamp profiles and how to prepare the pipe

Joint structure	Range of diameters	Clamp profile	Method for treating the pipe end	
			Diameter calibration	Beveled edges
 KAN-therm Press LBP Spacer ring color	16	U or TH	No	No
	20		No	No
	25		Recommended	No
	26	C or TH	Recommended	No
	32	U or TH	Recommended	No
	40*	U or TH	Yes	Yes
	50	TH	Yes	Yes
	63	TH	Yes	Yes

\* Fittings of 40 mm in diameter do not have the function of leakage control.

— Tools for pretreatment of composite pipes:

1. For pipes with diameters between 14–32 mm, convenient and handy pistol shears can be used.

①



2. For pipes with diameters between 16–63 mm, use roll cutters.

②



— Tools for multilayer and chamfering:

1. Universal calibrators (multi-diameter): 16/20/25–26 mm, 25–26/32/40 mm, 50/63 mm.

①



In the case of 16–32 mm Press LBP fittings, calibration is not required, but it makes installation easier.

— Tools for multilayer pipe profiling:

1. 14–26 mm inner bending spring.

①



2. 14–26 mm outer bending spring.

②



# Installation

## Speed, comfort and safety of installation.

Tight and secure connections in the KAN-therm Press LBP system are achieved by clamping a steel sleeve on the pipe and the fitting.

Joints are made with easy to use and versatile tools. Joints do not require additional seals, such as tape or tows.

KAN-therm Press LBP was designed based on the "quick installation – lasting effect" principle, which provides measurable acceleration of investment and finishing works.

With its unique component design, the installation of KAN-therm Press LBP is extremely simple, quick and, above all, safe.

1. Pipe cutting with pistol or roller shears.

2. Profiling the pipe with a spring.



3. Calibrating and chamfering the pipe end – not required for Press LBP fittings.

4. Insert the pipe all the way into the fitting.



5. Placing clamping jaw on the fitting.

6. Starting the press drive and clamping the joint.

7. Unlocking and removing the jaw from the fitting. The joint is ready for a leak test.



## Awards and certificates

### Press LBP fittings

Press LBP fittings, the new technical concept of KAN-therm Press were rewarded with numerous prestigious awards for its innovation, originality and quality, and have been approved by the major Western certifying bodies.

1. Golden Emblem Quality International 2015, 2014 and 2013 in the category Qi Product for KAN-therm SYSTEM – top quality product.i

2. Readers' award of the trade magazine "Systemy Instalacyjne" for an innovative System of the Year 2011.

3. The "Golden Installer 2011" statue, awarded by the "Instalator Polski" magazine and the Polish Corporation of Sanitation, Heating, Gas and Air Conditioning.

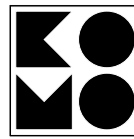

## Quality

KAN-therm Press LBP ensures correct joints, safety; long-term, trouble-free operation guaranteed.

The production of the system's components is subject to strict supervision by our well-equipped research lab. The manufactured components are also tested by external laboratories.

The production, as well as the entire company operation, is under the supervision of ISO 9001 quality management, certified by the reputable Lloyd's Register Quality Assurance Limited.



## Implementation

The best proof of the high quality of KAN-therm Press/Press LBP is provided by our numerous projects in various sectors of construction.

Although they remain hidden on a day-to-day basis, installations based on the KAN-therm System have been working flawlessly in major residential estates, public facilities, single-family homes, sports and recreation facilities, as well as industrial halls and factories for over 20 years now.

The KAN-therm Press/Press LBP System is ideal for both new investments and buildings under repairs; it can therefore be found in some of the oldest historic buildings and religious structures.

1. An office building „Tensor”  
- Gdańsk, Poland.



2. "MotoArena" speedway  
- Toruń, Poland.



4. Podlasie Opera and Philharmonic  
- Białystok, Poland.



5. Housing Estate „City Park”  
- Poznań, Poland.



7. Porsche Salon, Niederrhein  
- Moers, Germany  
Image © www.porsche-moers.de.

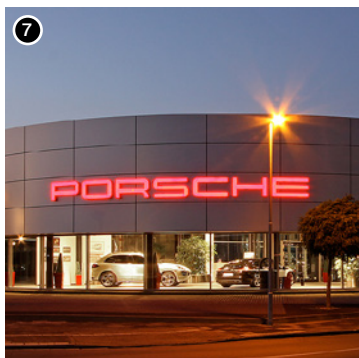

8. Office center „Red Rose”,  
Headquarters of Yandex  
- Moscow, Russia.



9. Housing Estate  
- Zagreb, Croatia.

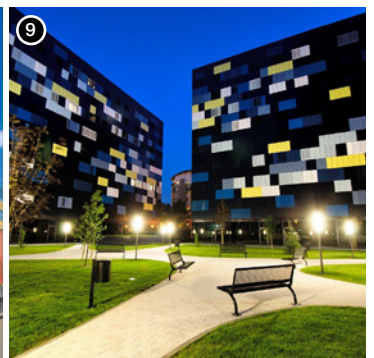

10. Aqua Park - Minsk, Belarus.

























11. "Szachname" residential complex  
- Odessa, Ukraine.



# SYSTEM **KAN-therm**

**Optimal, complete multipurpose installation system consisting of state of the art, mutually complementary technical solutions for pipe water distribution installations, heating installations, as well as technological and fire extinguishing installations.**

It is the materialization of a vision of a universal system, the fruit of extensive experience, the passion of KAN's constructors, strict quality control of our materials and final products, and vast knowledge of the market of installations to meet the requirements of energy efficient, sustainable construction.

	UltraLine	
	Push/Push Platinum	
	Press LBP	
	PP	
	Steel	
	Inox	
	Copper	
	Sprinkler	
	Surface heating and automation	
	Football Stadium installations	
	Cabinets and manifolds	

**KAN** Sp. z o.o.  
e-mail: [kan@kan-therm.com](mailto:kan@kan-therm.com)