

Ø 12-108 mm



SYSTEM **KAN-therm**

Steel

Traditional material
in modern technology

EN 2018



TECHNOLOGY OF SUCCESS



ISO 9001



About KAN

Innovative water and heating solutions

KAN was established in 1990 and has been implementing state of the art technologies in heating and water distribution solutions ever since.

KAN is a European recognized leader and supplier of state of the art KAN-therm solutions and installations intended for indoor hot and cold tap water installations, central heating and floor heating installations, as well as fire extinguishing and technological installations. Since the beginning of its activity, KAN has been building its leading position on such values as professionalism, innovativeness, quality and development. Today, the company employs over 600 people, a great part of which are specialist engineers responsible for ensuring continuous development of the KAN-therm system, all technological processes applied and customerservice. The qualifications and commitment of our personnel guarantees the highest quality of products manufactured in KAN factories.

Distribution of the KAN-therm system is performed through a network of commercial partners all over Poland, Germany, Russia, Ukraine, Belarus, Hungary, Ireland, the Czech Republic, Slovakia, Romania, in Scandinavia and in the Baltic States. Our expansion and dynamic development has proven so effective that KAN-therm labeled products are exported to 60 countries, and our distribution network assumes Europe, a great part of Asia, and a part of Africa.

The KAN-therm system is an optimal, complete multipurpose installation system consisting of state of the art, mutually complementary technical solutions for pipe water distribution installations, heating installations, as well as technological and fire extinguishing installations. It is the materialization of a vision of a universal system, the fruit of extensive experience, the passion of KAN's constructors, as well as strict quality control of our materials and final products.



SYSTEM KAN-therm
- special award:
Pearl of the highest quality
and:
Golden Quality International Medal
2015, 2014 i 2013.

TECHNOLOGY OF SUCCESS



Table of contents

- 3 System KAN-therm Steel
- 4 Advantages
- 5 Application
- 6 Pipes
- 7 Fittings
- 8 Tools
- 9 Assembly
- 10 Additional information
- 11 Past projects

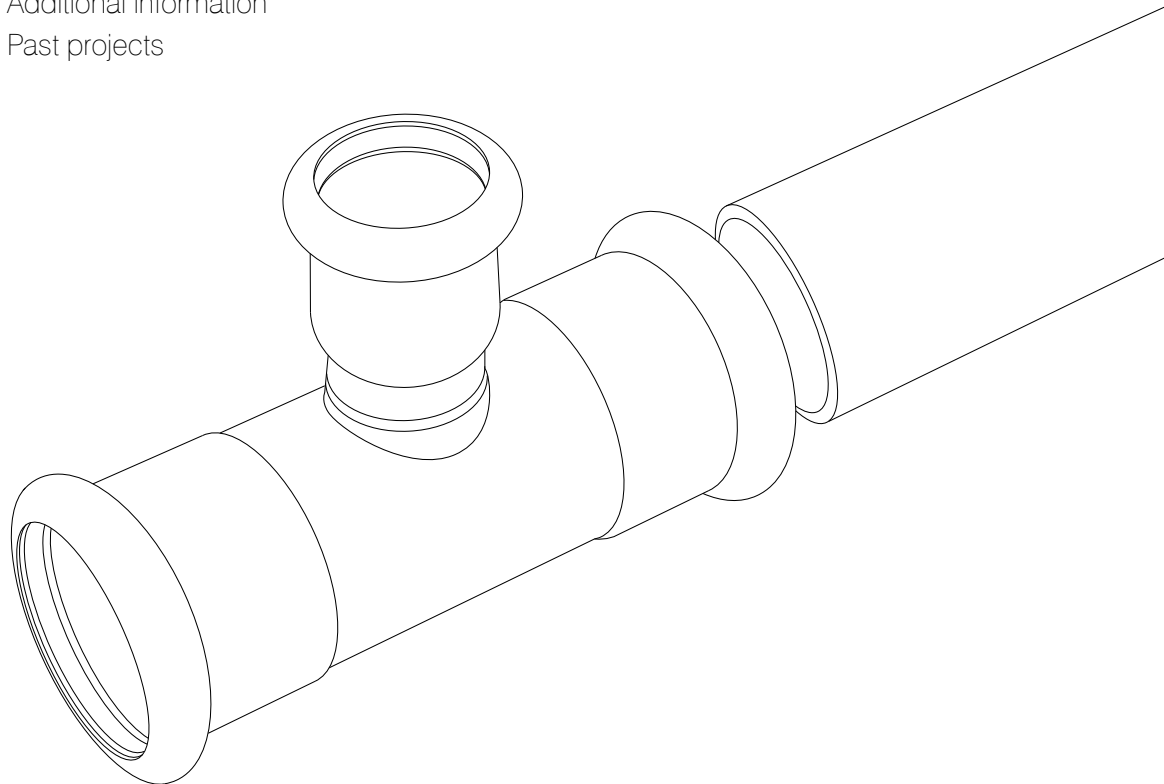

SYSTEM **KAN-therm**

Steel

KAN-therm Steel is a complete, state of the art installation system consisting of pipes and fittings made of zinc-plated carbon steel. The “press” technology applied in the KAN-therm Steel System allows for performing fast and tight joints by pressing them with generally available crimping profiles, eliminating the need to thread or weld particular system elements. Thanks to this solution the process of assembling an installation, even with large-diameter pipes and fittings, is reduced to the absolute minimum.

Due to the material specification of the system as well as an extensive range of diameters, the KAN-therm Steel system is suitable for constructing complete, indoor heating, cooling installations, tap water installation in single- and multi-family buildings, as well as public buildings.

Thanks to fast, easy and, most of all, safe assembly without the use of flames or high temperature, the system is particularly recommended for replacing old, corroded, steel heating installations.

Advantages

— fast and easy assembly

Thanks to "Press" technique, the assembly of pipes and fittings was reduced at least by half, compared to traditional steel systems jointed through welding or threading.

— safety and reliability

Assembly is performed without the use of open fire, which has essential impact in replacements of old heating installations in multi-family buildings. Moreover, all system fittings are equipped with the LBP (Leak Before Press) function of signaling ill-pressed joints.

— ideal solution for old installations

Thanks to a wide range of diameters (12–108 mm), and comprehensive offer of elements, high durability, attractive price and technical and usage values, the KAN-therm Steel system is particularly recommended for modernizations of old heating installations.

— highest esthetic and resistance to corrosion

Installations performed in the KAN-therm Steel System are characterized by esthetic appearance and may be used without additional paint coatings. An installation consisting of standard system elements will suit every décor.

— high mechanic durability

Secures the installation, particularly in generally accessible rooms, against any effects of vandalism. For this purpose, the system is particularly recommended for use in all public buildings, such as schools, shopping centers, cinemas, exhibition halls, which are particularly exposed to such actions.

— resistance to high pressure and temperature

Thanks to the use of the "Press" assembly technique, professional pressing tools and highest quality O-rings, the system will operate at 16 bar and 200 °C.

— reduction of pressure loss

Fitting's constructions allows for minimizing the diameter narrowing phenomenon (the bottleneck effect), which results in reduced pressure loss in the pipe-fitting joint, ensuring optimal flow of the medium through the entire installation.

LBP function
(Leak Before Press)
– signaling of
ill-pressed joints.



Application



The system is used in multi-family housing and public buildings, to construct new, indoor heating installations.

Its material specification and comprehensive range of products allows for performing complete, closed-circuit pressure installations (without the access of air to installation medium).

Due to the simplicity and safety of assembly, thanks to secure and fully tested "Press" assembly technique (which does not require the use of open fire), the KAN-therm Steel System is recommended for replacing old, corroded steel heating installations in multi-family buildings.

Low thermal elongation of pipes and esthetic appearance of finished system elements (zinc-plated pipes and fittings) make the system ideal for on-plaster heating installations. KAN-therm Steel is the perfect alternative for renovating old, historical buildings which do not offer the possibility of placing the installation in structural partitions (only on-plaster installation).

After consulting with KAN's Technical Department, there is a possibility of applying the system in non-standard installations, such as compressed air.

- **central heating installations in closed circuit (pressurized)**
- **chilled water installations**
- **non-standard applications (after consultation with KAN's Technical Department)**



Pipes

Esthetic and resistance to corrosion

KAN-therm Steel pipes are made of RSt 34-2 carbon steel, material number 1.0034 according to DIN EN 10305-3.

KAN-therm Steel pipe wall thickness

Pipe length	12-18 mm	22-66.7 mm	76-108 mm
6m bar	1.2 mm	1.5 mm	2 mm



Pipes and fittings are secured against corrosion with a layer of zinc-plating (Fe/Zn 88) of 8-15 μm , applied on the external surfaces of all elements.

This solution allows for using pipes and fittings without additional paint coatings. An installation consisting of standard system elements will suit every décor.

Material type	Lineal elongation coefficient	Elongation with temperature increase by 60°C at 4m	Thermal conductivity
	[mm/m x K]	[mm]	[W/(m ² x K)]
Steel	0.0108	2.59	58

For the duration of transport, pipes are additionally secured on the inside with a thermally-applied oil layer.





Fittings

Reliability and reduction of pressure loss

KAN-therm Steel fittings are made of the same material as pipes – RSt 34-2 carbon steel, material number 1.0034 according to DIN EN 10305-3.

Similarly to pipes, fittings are also secured against corrosion with a layer of galvanized zinc-plating applied on the external surfaces of all elements.

The “press” technology applied in the KAN-therm Steel System allows for producing fast and tight joints by pressing them using generally available crimping profiles, eliminating the need to thread or weld particular system elements. Thanks to this solution the process of assembling an installation, even with large-diameter pipes and fittings, is reduced to the absolute minimum.

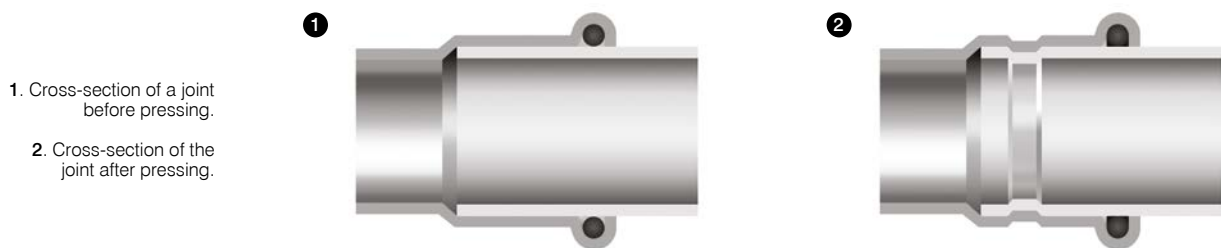

1. Cross-section of a joint before pressing.

2. Cross-section of the joint after pressing.

Joining system elements in the “Press” technology allows for acquiring joints with minimum pipe cross-section narrowing, which considerably reduces pressure loss in the entire installation and produces excellent hydraulic conditions.

3. Four-point grip in the KAN-therm Steel system.

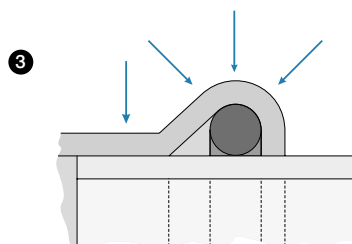

Tightness and reliability of joints in the KAN-therm Inox System is guaranteed by special O-ring seals and the four-point type “M” grip system.

Tools

Professionalism and safety

KAN-therm Steel is not only pipes and fittings, but also a wide range of professional, advanced tools for safe and secure performance of element joints.

Our offer includes electrical or battery-powered tools created by renowned companies, the selection of which depends on the diameter of the pipes assembled.

REMS Tools:

- 1. Aku Press.
- 2. Power Press SE.
- 3. M12-54mm jaws.



KLAUKE Tools:

- 4 UAP 100 press.
- 5. KSP3 76,1-108mm jaws.



NOVOPRESS Tools:

- 6. ECO 301 press.
- 7. S7. M12-28mm jaws.
- 8. HP 35 Snap On jaws.
- 9. HP 42, HP 54 Snap On jaws.
- 10. ZB 303 adapter.

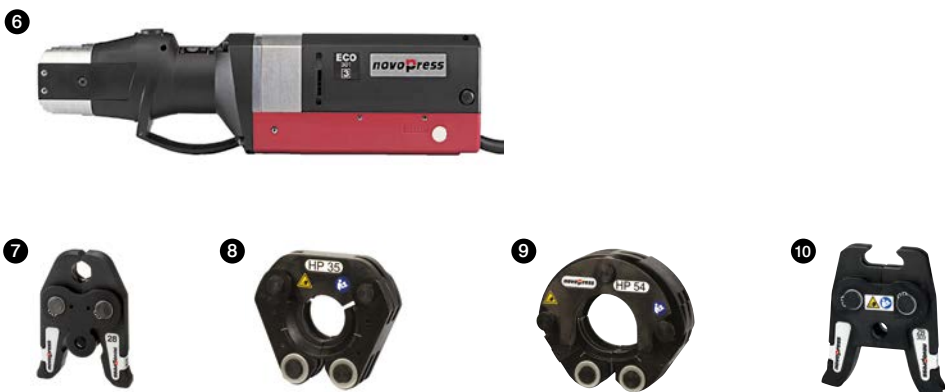

- 11. ACO 401 press.
- 12. HP 76.1 – 168.3 jaws.



— devices for preliminary treatment



Easy and quick assembly

Joining KAN-therm Steel System elements is performed utilizing a simple, fast and, most importantly, safe (without open flames) "Press" technique, based on pressing the fitting on the pipe using special tools.

All tools designed for use with the KAN-therm Steel System are easy to use and do not require any special licenses to operate.

1. Pipe cutting using special rotary cutters – cut perpendicularly to the pipe.

a - for diameters of up to 54mm, inclusive.
b - for diameters above 54 mm

2. Chamfering the external and internal surface of the pipe end using special chamfers or files.

a - for diameters of up to 54mm, inclusive
b - for diameters above 54 mm.

3. Marking the required pipe insertion depth – necessary for obtaining proper joint tightness.

4. Inspection for the presence of o-ring in the fitting.

5. Insertion of the pipe into the fitting to the required depth.

6. Placement of jaws on the fitting and pressing.



a - for diameters of up to 54mm, inclusive
b - for diameters above 54 mm.



O-rings

Resistance to high pressure and temperature

KAN-therm Steel System fittings are, by standard, equipped with special O-rings. Depending on the required operating parameters for the system and the type of medium transported, fittings may be equipped with three types of O-rings: EPDM (factory-mounted), and FPM/Viton (replaced by the client).

O-ring name	Properties and operating parameters	Application
EPDM ethylene-propylene rubber		
	diameter range: 12-108 mm color: black max operating pressure: 16 bar operating temperature: -35°C to 135°C short-term: 150°C	potable water conditioned water (softened, decalcinated, distilled, with glycol) compressed air without oil
FPM/Viton fluoride rubber		
	diameter range: 12-108 mm color: green max operating pressure: 16 bar operating temperature: -30°C to 200°C short-term: 230°C	solar installations (glycol) compressed air fuel oil vegetable fat engine fuels Notice: do not use in potable water and pure hot water installations

All KAN-therm Steel System fittings offer the LBP function (signaling of ill-pressed joints, LBP – Leak Before Press). Ill-pressed joints are not water-tight and thus easy to locate.

1. O-ring action with the LBP function of leakage detection.

2. LBP o-rings with a function of leakage detection.

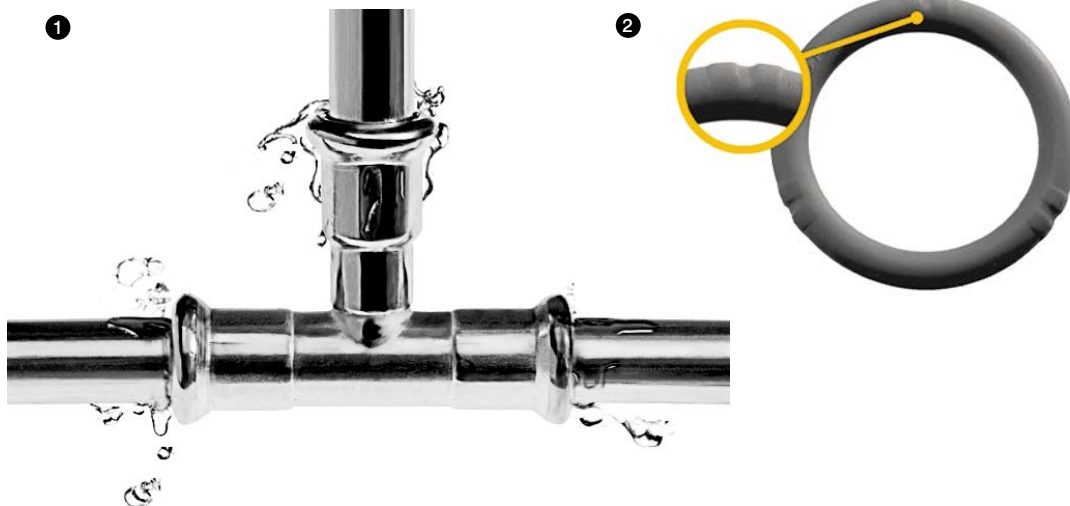

In the 12-54mm diameter range, the LBP function is performed by specially structured O-rings, equipped with special furrows, which ensure full and optimal control over the joints during pressure tests.

In the 66.7-108mm diameter range, the LBP function is performed by a special structure of the fitting's stub pipe, that is through minimal increase of the internal diameter of the fitting in relation to the external diameter of the pipe.



High quality

High quality of KAN-therm Steel System elements is guaranteed by Polish certifying body ITB and the French certifying body CSTBat.

KAN-therm Steel System pipes and fittings are certified according Russian standards and hold technical approval NL.31.140086.

Past projects

All our past projects performed in the KAN-therm Steel System, both in Poland and abroad are the ideal confirmation of the highest quality of our products:

1. Krakow University of Technology
– Krakow, Poland.



2. Speedway stadium MotoArena
– Toruń, Poland.



3. Spodek – Katowice, Poland.



4. Main Railway Station
– Wrocław, Poland.

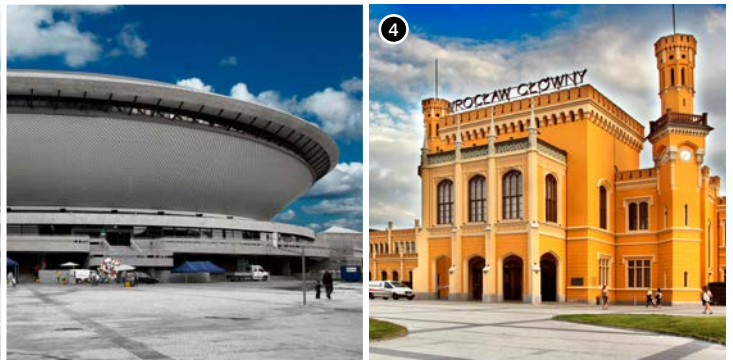

5. Old Trafford, Manchester
United Stadium – Manchester,
England, photo © Tom Jeffs.



6. Sky Towers Office building
– Minsk, Belarus.

7. Annunciation Cathedral
– Voronezh, Russia.

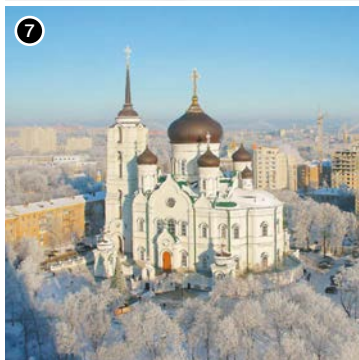



















8. Ukrainian Theater
– Odessa, Ukraine.



SYSTEM **KAN-therm**

Optimal, complete multipurpose installation system consisting of state of the art, mutually complementary technical solutions for pipe water distribution installations, heating installations, as well as technological and fire extinguishing installations.

It is the materialization of a vision of a universal system, the fruit of extensive experience, the passion of KAN's constructors, strict quality control of our materials and final products, and vast knowledge of the market of installations to meet the requirements of energy efficient, sustainable construction.

	Push Platinum	
	Push	
	Press LBP	
	PP	
	Steel	
	Inox	
	Sprinkler	
	Surface heating and automation	
	Football Stadium installations	
	Cabinets and manifolds	



KAN Sp. z o.o.
ul. Zdrojowa 51, 16-001 Białystok-Kleosin
tel. +48 85 74 99 200, fax +48 85 74 99 201
e-mail: kan@kan-therm.com

www.kan-therm.com