

Ø 12-108 mm



SYSTEM **KAN-therm**

Steel

Traditional material  
in modern technology



TECHNOLOGY OF SUCCESS



ISO 9001

# Contents

## 5 System **KAN-therm** Steel

Modern connection technology .....	141
Long-lasting connection technology .....	142
Application possibilities .....	142
Advantages .....	142
Fitting assembly .....	142
Tools .....	147
Tools - safety .....	149
LBP Function .....	149
Detailed information .....	149
Elongation and thermal conductivity data .....	150
Guidelines for applications .....	150
Screw connections and joining with other KAN-therm Systems .....	150
Pipeline assembly .....	151
Fixed (PS) and slidable (PP) points .....	152
Elongation compensation .....	152
„L”, „Z”, and „U” compensator selection .....	153
<b>System KAN-therm Steel - assortment .....</b>	<b>155</b>
<b>Tools for Steel .....</b>	<b>167</b>



## 5 System **KAN-therm Steel**

System KAN-therm Steel is a system made of carbon steel pipes and fittings of diameters 12 to 108 mm. Pipes and fittings produced of high quality carbon steel covered with thin zinc layer which protects external surface against corrosion.

### **Modern connection technology**

“Press” technology used in System KAN-therm Steel enables to make fast and reliable connections by pressing fittings using widely available press tools, and to eliminate twisting and welding of individual elements. The system permits a very quick assembly even when using pipes and fittings in large diameters.

System KAN-therm Steel pipes and fittings are made of thin-walled steel, which significantly decreases weight of individual elements and facilitates system assembly.

Connecting elements in “press” technology allows to obtain connections with minimized pipe section narrowing, which significantly decreases waste of system pressure and creates excellent hydraulic conditions.

## Long-lasting connection technology

Connection leak tightness in System KAN-therm Steel is provided by special O-Ring seals and a three-point crimping profile „M”.

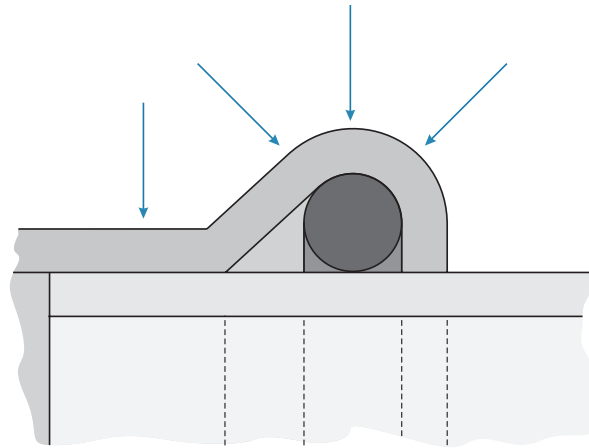

## Application possibilities

- closed water heating installation (cannot be used for potable water installations),
- closed cooling water systems.

## Advantages

- quick and reliable system assembly without welding and twisting,
- wide range of pipe and fitting diameters up to 108 mm,
- wide range of operating temperatures: from -35°C to 135°C,
- high operating pressure up to 16 bar,
- compatible with plastic systems KAN-therm Press and Push,
- lightweight pipes and fittings,
- system high aesthetics,
- resistance to mechanical damage.

## Fitting assembly



### 1 Pipe cutting

Pipes should be cut perpendicular to their axes using pipe roll-cutter (full cut, with no breaking off nicked pipe segments). Using other tools is permissible provided the cut is perpendicular and cut edges are not damaged (no breaking off, no material decrements or other deformations of pipe section). Tools that emit a lot of heat, e.g. a flame torch, an angle grinder, etc., cannot be used.



## 2 Beveling

Using a hand operated stripping tool (for 66,7-108 mm half-rounded steel file), bevel outside and inside the tip of the cut pipe, and remove all file dust that can damage an O-Ring during assembly. Stripping tool may also be mounted on electric machines (for instance electric drill).



## 3 Marking the insertion depth of the pipe in the fitting

In order to obtain proper connection strength it is necessary to keep the correct insertion depth (Tab.1, Fig 1 ) of the pipe in the fitting (it should be slid home). To make sure the pipe is properly slid into the fitting during pressing, mark the required insertion depth with a pen marker. After the connection have been made, the marking should be visible just next to edge of the fitting. Also, there are special markers for marking the insertion depth.

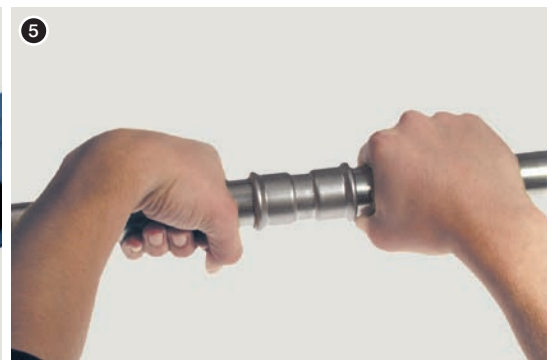

## 4 Control

Before assembly, check visually that there is an O-Ring in the fitting, whether it is not damaged, and whether there are no file dust or any other sharp objects which can cause damage to the O-Ring during assembly. In order to proper assembling it is necessary to check the minimal allowed distance between the fittings according to Table. In order to proper assembling it is necessary to check the minimal allowed distance between the fittings according to Table 1. Fig.1).

## 5 Pipe and fitting assembly

Before making the connection, axially insert the pipe into the fitting to a marked depth (To make the assembly easier it is possible to slightly twist the pipe in relation to the fitting).

Using any kinds of oils, lubricating oils and fats in order to make the montage of the pipe into the fitting easier is not allowed (it is allowed to use only water or spoiled soap - recommended in case of pressure test by air) In the case of making many connections (inserting pipes into fittings and pressing) it is very important to watch the pipe insertion depth. To do so watch previously made markings on pipes near fitting edges.



## 6 Making a press connection

Before the beginning of the process of making the press connection, please check the efficiency of tools. Recommended is the usage of pressing machine and jaws provided by the System KAN-therm. Always choose the suitable size of the jaw to the diameter of executing connection. The jaw should be placed on the fitting in the way, which will ensure that the grooves in the jaw will cover the space, where are the O-Rings placed (raised parts of the fitting). After start of pressing, the process takes place automatically and cannot be stopped. If for some reasons the process of the pressing will be aborted, the connection need to be disassembled (cut out) and then the new connection should be executed one more time in correct way. If the contractors have different machines and jaws than those supplied by KAN, every use of them must be consulted with the KAN company individually.

## 7 Making a press connection in range 66,7–108 mm Preparing the jaw

To make a press connection of the three biggest dimensions of the Steel (64; 66,7; 76,1; 88,9; 108) a special jaws should be used (tetramerous) and the Klauke pressing machine. The jaw after release should be unlocked by removing the special bolt.



## 8 Locking the jaw

Unlocked jaw need to be put on the fitting. The jaw has special groove, where the fitting edge need to be placed.

**!** Caution The label on the jaw should be always at the pipe side (see picture).

- 9 After the correct assembling the jaw onto the fitting, the jaw need be to locked using the special bolt. At this moment the jaw is ready to do the connection.

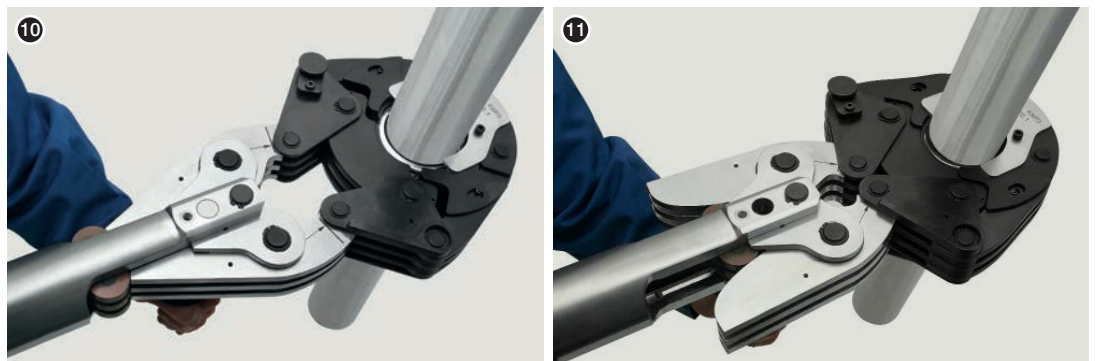

- 10 **Assembling the machine to the jaw**

The machine need to be connected with the jaw in the way how it is shown on the picture. The arms of the machine have to be slip in up to the end. Maximal slip in is marked on the arm of the machine. Now, the machine is ready to be started.

- 11 **Making a connection**

The time of the full press connection is about 1 min. After the start of pressing, the process takes place automatically and cannot be stopped. If, for some reasons the process of the pressing will be aborted, the connection need to be disassembled (cut out) and then the new connection should be executed one more time in correct way. After the connection is finished, the machine will automatically back to the previous position. The arms of the machine need to be move out form the jaw. To remove the jaw from the fitting, the jaw need to be unlocked. The jaws should be stored in the locked box.

Check and lubricate the equipment before starting work and during the intervals determined by the producer.

Press conection before and after press

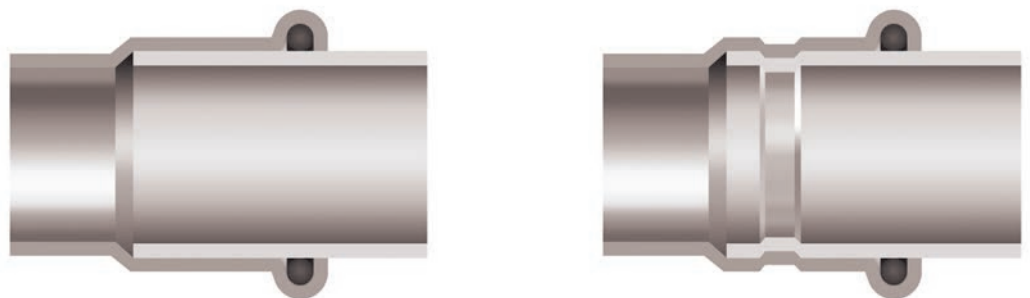

## Mounting distance

Table 1. Pipe insertion depth in the fitting and minimum distance between pressed fittings

$\varnothing$ [mm]	A [mm]	$d_{min}$ [mm]
12	17	10
15	20	10
18	20	10
22	21	10
28	23	10
35	26	10
42	30	20
54	35	20
64	50	30
66,7	50	30
76,1	55	55
88,9	63	65
108	77	80

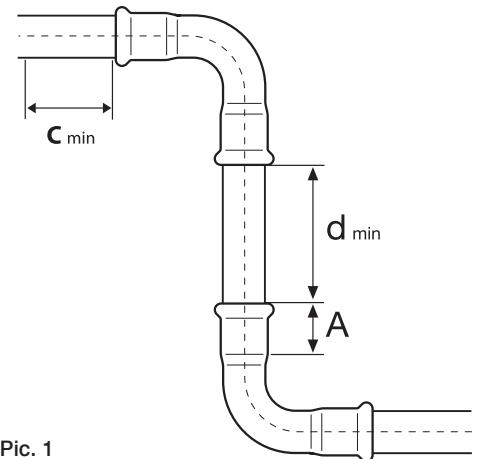

Pic. 1

A – Pipe insertion depth in the fitting,

$d_{min}$  – minimum distance between fittings allowing for press correctness

Table 2. Minimum assembly distances

$\varnothing$ [mm]	Rys. 2		Rys. 3		
	a [mm]	b [mm]	a [mm]	b [mm]	c [mm]
12/15	56	20	75	25	28
18	60	20	75	25	28
22	65	25	80	31	35
28	75	25	80	31	35
35	75	30	80	31	44
42	140/115*	60/75*	140/115*	60/75*	75
54	140/120*	60/85*	140/120*	60/85*	85
64	145*	110*	145*	100*	100*
66,7	145*	110*	145*	100*	100*
76,1	140*	110*	165*	115*	115
88,9	150*	120*	185*	125*	125
108	170*	140*	200*	135*	135

\*applies to four-part pressing jaws

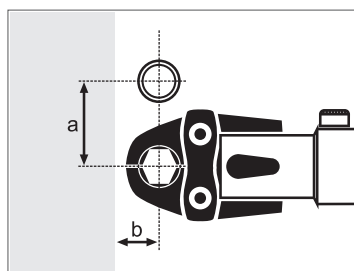

Pic. 2

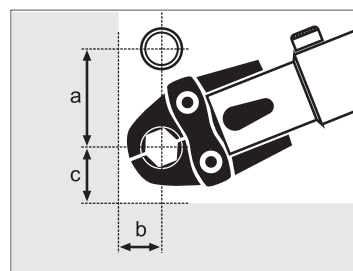

Pic. 3

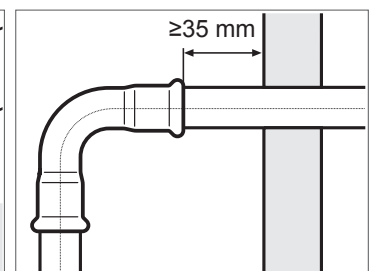

Pic. 4



## Tools

Depending on the diameter, KAN-therm provides various configuration of tools. In order to select optimal set of tools, please follow chart:

**Tab. 3 Selection of tools table: System KAN-therm Steel & Inox**

Brand	Press machine		Diameter [mm]	Press jaws / collars		Adapter		Type of System KAN-therm			
	Marking	Code		Marking	Code	Marking	Code	Steel	Inox	Steel Sprinkler	Inox Sprinkler
REMS	Power Press E Aku Press ZAPR01 ZAPRAK		12	M12	570100	-	-	+	-	-	-
			15	M15	570110	-	-	+	+	-	-
			18	M18	570120	-	-	+	+	-	-
			22	M22	570130	-	-	+	+	-	-
			28	M28	570140	-	-	+	+	-	-
			35	M35	570150	-	-	+	+	-	-
			42	M42	570160	-	-	+	+	-	-
			54	M54	570170	-	-	+	+	-	-
KLAUKE	UAP100	UAP100	64	KSP3 64	BP64M	-	-	+	-	-	-
			67	KSP3 66,7	BP667M	-	-	+	-	-	-
			76,1	KSP3 76,1	BP761M	-	-	+	+	-	-
			88,9	KSP3 88,9	BP889M	-	-	+	+	-	-
			108	KSP3 108	BP108M	-	-	+	+	-	-
NOVOPRESS	ECC301	620570.5	12	M12	620572.7	-	-	+	-	-	-
			15	M15	620573.8	-	-	+	+	-	-
			18	M18	620574.9	-	-	+	+	-	-
			22	M22	620575.1	-	-	+	+	+	+
			28	M28	620576.0	-	-	+	+	+	+
			35	HP 35 Snap On	634106.0	ZB 303	634111.5	+	+	+	+
			42	HP 42 Snap On	634107.1			+	+	+	+
			54	HP 54 Snap On	634108.2			+	+	+	+
	66,7	M 67	634139.0	ZB 323	634143.4	+	+	-	-		
	ACO401	634008.1	76,1	HP 76,1	634009.2	-	-	+	+	+	+
			88,9	HP 88,9	634010.3	-	-	+	+	+	+
			108	HP 108	634011.4	-	-	+	+	+	+
			139,7	HP 139,7	BF139	-	-	-	+	-	-
			168,3	HP 168,3	BF168	-	-	-	+	-	-

### REMS tools:

1. Aku Press machine
2. Power Press E machine
3. Press jaw M12 – 54 mm



### KLAUKE tools:

1. UAP100 machine
2. Press collar KSP3 64 – 108 mm

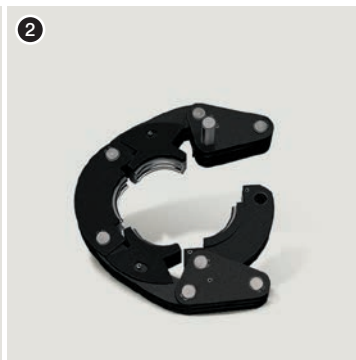

### NOVOPRESS tools:

1. ECO 301 machine
2. Press jaw M12-28
3. Press collar HP 35 Snap On



4. ACO 401 machine
5. Press collar HP 42 – 54 Snap On
6. Collar M67

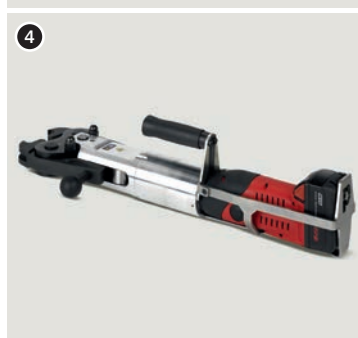

7. Press collar HP 76,1 – 168,3
8. Adapter ZB 303
9. Adapter ZB 323

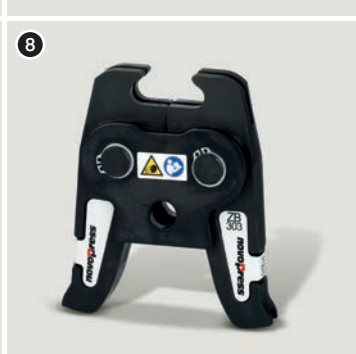

## Tools - safety

All tools must be applied and used in accordance with their purpose and the manufacturer's instructions.

Use for other purposes or in other areas are considered to be inconsistent with the intended use.

Intended use also requires compliance with the instructions, conditions of inspection and maintenance and relevant safety regulations in their current version.

All works done with tools, which do not meet the application compatible with the intended purpose may result in damage to tools, accessories and pipes. The consequence may be the leak and / or damage.

## LBP Function

All the KAN-therm Steel System fittings have LBP function (signaling unpressed connections - LBP-Leak Before Press). In scope of 12–54 mm diameters the function is implemented by means of special construction of O-rings. Thanks to their special grooves, the LBP O-rings guarantee optimal connection control during pressure test.

Unpressed connections are leaky and therefore easy to locate. In diameters over 54 mm the LBP function is realized by means of an appropriate fitting construction (fitting socket ovalization).

1. The activity of O-Rings with the function of signalling not pressed connections (LBP).
2. O-Rings with the function of signalling not pressed connections (LBP)

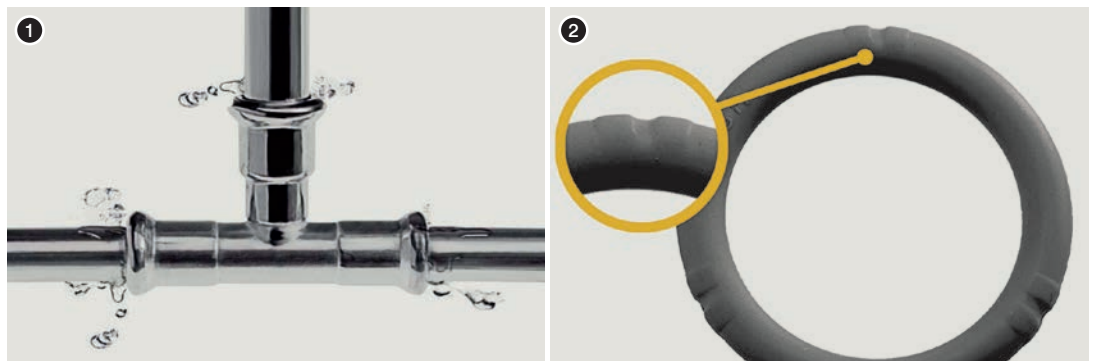



## Detailed information

### Pipes and fittings - material

Carbon steel RSt 34-2 (1.0034 acc. DIN EN 10305-3), pipes externally zinc coated (Fe/Zn 88), zinc layer thickness 8-15  $\mu\text{m}$ .

### O-Rings and flat gaskets

O-Ring	Properties and work parameters	Application
<p>EPDM (butyl rubber)</p> 	<p>color: black                      max. operating pressure: 16 bar                      operating temperature: -35°C to 135°C                      short duration: 150°C</p>	<p>potable water                      hot water                      treated water                      (softened, decalcified, distilled, with glycol up to 50%)                      compressed air (dry)</p>
<p>FPM / Viton (fluorine rubber)</p> 	<p>color: green                      max. operating pressure: 16 bar                      operating temperature: -30°C to 200°C                      short duration: 230°C</p>	<p>solar systems                      compressed air                      fuel oil                      vegetable fat                      engine fuels                      Caution                      Not suitable for pure hot water applications.</p>

O-Ring	Properties and work parameters	Application
Flat gasket FPM Viton 	colour: green maks. operating pressure: 16 bar operating temperature: -30°C to 200°C, short-term: 230°C	solar installations (glycol) compressed air heating oil vegetable fats motor fuels Caution!! do not use in clean hot water systems.



### Fittings come with standard EPDM O-Rings.

For special applications, Viton O-Rings are delivered separately. In case of exchanging the standard EPDM to the VITON O-Rings, it is not allowed to use again the dismantled O-Rings. Areas of application that are outside the elementary scope of the closed heating installations, should be always consulted with the company KAN.

## Elongation and thermal conductivity data

Material	Linear elongation coefficient [mm/(m×K)]	Elongation of 4 m segment at 60°C [mm]	Thermal conductivity [W/(m²×K)]
Steel	0,0108	2,59	58

## Guidelines for applications

- KAN-therm Steel pipes cannot be bent when warm. Cold bending is permissible provided the minimum bending radius is kept ( $R=3.5 \times dz$ ). Do not expose pipe external surface to prolonged direct moisture during storage and use.
- Pipes over  $\varnothing 28$  mm should not be bent.
- Use ready-made pipe bends or 90° and 45° elbows offered by System KAN-therm Steel.
- It is not allowed to cut pipes using tools which emit a lot of heat, e.g. flame torches or grinders. To cut KAN-therm Steel pipes use only pipe cutters (hand operated and mechanical).
- Systems filled with water should not be emptied. In the case a system has to be emptied after a pressure test, it is advised to perform pressure tests using compressed air.
- When KAN-therm Steel system is concealed in building elements, pipes and fittings should be tightly insulated, allowing for compensation of thermal elongation and building chemicals protection.
- If pipes and fittings of System KAN-therm Steel may contact with water or other corrosive environment it is necessary to use tight anti-corrosion protection. The thickness of used insulation should make possible free thermal movement of installation – compensation.
- In the case of transporting chemical substances the possible use of KAN-therm Steel pipes should be consulted with KAN Technical Department.
- System KAN-therm Steel installations require potential equalization.

## Screw connections and joining with other KAN-therm Systems

System KAN-therm Steel offers the wide range of male and female threaded fittings. Because in the Steel and Inox fittings threads are the cone-shaped, to make a connections with KAN-therm Push and Press brass fittings, use only male threads with the small quantity of tow at the brass side. To not stress the press connection, it is advised to make a screw connection before the press one.

Recommended method of connecting plastic systems (Push, Press) with steel systems (Steel, Inox) is a properly made screw connection.

Male brass fitting System KAN-therm Push, Press

Female steel fitting System KAN-therm Steel, KAN-therm Inox

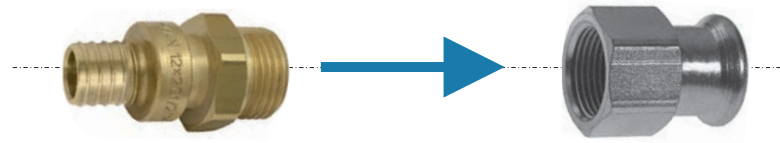

### Thread sealing

It is advised to seal threaded connections with such an amount of tow, that leaves the thread tops not covered. Using too much tow may lead to thread damage. By winding tow just after the first thread ridge you can avoid skew screwing and damaging the thread.



### Caution

Do not use chemical sealants or glues.

Elements of the System KAN-therm Steel can be assembled (through the screw or flanged connections) with elements made of others materials (see the table below).

#### Possibility of connections for Systems KAN-therm Steel and Inox with other materials

Type of installation		Pipes/Fittings			
		Copper	Bronze/Brass	Carbon steel	Stainless steel
Steel	closed	yes	yes	yes	yes
	open	no	no	no	no
Inox	closed	yes	yes	yes	yes
	open	yes	yes	no	yes

Remember, that connecting directly the elements made of the stainless steel with the elements made of zinc plated carbon steel (eg. pipes) can lead to corrosion. This process can be eliminated by using the plastic inserts or independent metal inserts (bronze, brass) with minimal length of 50 mm (eg. using the brass ball valve).

### Pipeline assembly

Maximum distances between attachment points are presented in Table 4:

Table 4 Maximum distances between pipeline attachment points

Pipe diameter [mm]	Distance between attachment points [m]
12	1,00
15	1,25
18	1,50
22	2,00
28	2,25
35	2,75
42	3,00
54	3,50
64	3,75
66,7	4,25
76,1	4,25
88,9	4,75
108	5,00

### Attachment points can be done as:

- slidable points PP - slidable points should enable free axial motion of the pipeline (caused by thermal motions), that is why they shouldn't be fixed next to the fittings (minimal distance from fitting flange must be higher than maximum elongated of pipeline). The slidable point can be made as "unscrewed" metal clamps with rubber pads,
- fixed points PS - to make fixed point, the metal clamp with rubber pad should be used, it should enable precise and reliability stabilization of the pipe on the whole circuit. The metal clamp should be maximally tighten on the pipe,
- attachment points preventing the pipeline from moving downwards; used if the pipeline movement on compensation arm length was blocked by required PP position.

### Fixed (PS) and slidable (PP) points

- fixed points should prevent any movement of pipelines and should be fixed next to fittings (at both sides of a fitting, e.g. coupling, tee connection),
- fixed or slidable points cannot be fixed directly onto fittings,
- when fixing PSs near tee connections make sure that clamps blocking the pipeline are not fixed onto branches of smaller diameters than one dimension in relation to the pipeline (forces induced by large diameter pipes can damage small diameters), PPs enable only axial motion of the pipeline (they should be treated as fixed points for perpendicular direction to the pipeline axis) and should be made by clamps,
- PPs should not be fixed next to fittings because this may block thermal motions of the pipeline,
- remember that PPs prevent the pipeline from moving transverse to its axis and that is why their position may determine compensation arms length.

### Elongation compensation

Along with water temperature rise  $\Delta T$  pipelines become elongated by  $\Delta L$  value. Thermal elongation  $\Delta L$  causes pipeline deformation on expansion compensation length  $A$ . Expansion compensation length  $A$  should not cause excessive stresses in the pipeline and depends on the pipeline external diameter, thermal elongation  $\Delta L$  and a linear expansion coefficient for a given material. Elongations  $\Delta L$  in function of pipe length  $L$  and temperature rise  $\Delta T$  are presented in Table 5:

Table 5 Total length elongation  $\Delta L$  [mm] – System KAN-therm Steel

L [m]	$\Delta T$ [°C]									
	10	20	30	40	50	60	70	80	90	100
1	0,11	0,22	0,32	0,43	0,54	0,65	0,76	0,86	0,97	1,08
2	0,22	0,43	0,65	0,86	1,08	1,30	1,51	1,73	1,94	2,16
3	0,32	0,65	0,97	1,30	1,62	1,94	2,27	2,59	2,92	3,24
4	0,43	0,86	1,30	1,73	2,16	2,59	3,02	3,46	3,89	4,32
5	0,54	1,08	1,62	2,16	2,70	3,24	3,78	4,32	4,86	5,40
6	0,65	1,30	1,94	2,59	3,24	3,89	4,54	5,18	5,83	6,48
7	0,76	1,51	2,27	3,02	3,78	4,54	5,29	6,05	6,80	7,56
8	0,86	1,73	2,59	3,46	4,32	5,18	6,05	6,91	7,78	8,64
9	0,97	1,94	2,92	3,89	4,86	5,83	6,80	7,78	8,75	9,72
10	1,08	2,16	3,24	4,32	5,40	6,48	7,56	8,64	9,72	10,80
12	1,30	2,59	3,89	5,18	6,48	7,78	9,07	10,37	11,66	12,96
14	1,51	3,02	4,54	6,05	7,56	9,07	10,58	12,10	13,61	15,12

**Table 5 Total length elongation  $\Delta L$  [mm] – System KAN-therm Steel**

L [m]	$\Delta T$ [°C]									
	10	20	30	40	50	60	70	80	90	100
16	1,73	3,46	5,18	6,91	8,64	10,37	12,10	13,82	15,55	17,28
18	1,94	3,89	5,83	7,78	9,72	11,66	13,61	15,55	17,50	19,44
20	2,16	4,32	6,48	8,64	10,80	12,96	15,12	17,28	19,44	21,60

## „L”, „Z”, and „U” compensator selection

**Table 6 Required expansion compensation length A [mm] for KAN-therm Steel System**

Elongation values $\Delta L$ [mm]	Pipe external diameters $d_z$ [mm]												
	12	15	18	22	28	35	42	54	64	66,7	76,1	88,9	108
2	220	246	270	298	337	376	412	468	509	520	555	600	661
4	312	349	382	422	476	532	583	661	720	735	785	849	935
6	382	427	468	517	583	652	714	810	882	900	962	1039	1146
8	441	493	540	597	673	753	825	935	1018	1039	1110	1200	1323
10	493	551	604	667	753	842	922	1046	1138	1162	1241	1342	1479
12	540	604	661	731	825	922	1010	1146	1247	1273	1360	1470	1620
14	583	652	714	790	891	996	1091	1237	1347	1375	1469	1588	1750
16	624	697	764	844	952	1065	1167	1323	1440	1470	1570	1697	1871
18	661	739	810	895	1010	1129	1237	1403	1527	1559	1665	1800	1984
20	697	779	854	944	1065	1191	1304	1479	1610	1644	1756	1897	2091
22	731	817	895	990	1117	1249	1368	1551	1689	1724	1841	1990	2193
24	764	854	935	1034	1167	1304	1429	1620	1764	1800	1923	2079	2291
26	795	889	973	1076	1214	1357	1487	1686	1836	1874	2002	2163	2385
28	825	922	1010	1117	1260	1409	1543	1750	1905	1945	2077	2245	2475
30	854	955	1046	1156	1304	1458	1597	1811	1972	2013	2150	2324	2561
32	882	986	1080	1194	1347	1506	1650	1871	2036	2079	2221	2400	2645
34	909	1016	1113	1231	1388	1552	1700	1928	2099	2143	2289	2474	2727

Table 6 presents required expansion compensation length A for different thermal elongation values  $\Delta L$  and pipe external diameters  $d_z$ .

Rules for selection of different types of compensators are given below:

### „L” type compensator

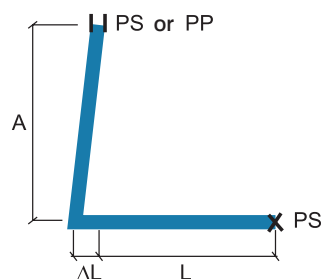

- $A$  – flexible arm length
- $PP$  – sliding support (allows only axial movement of a pipeline)
- $PS$  – fixed point (prevents any movement of a pipeline)
- $L$  – the initial length of a pipeline
- $\Delta L$  – pipeline thermal elongation

For compensation arm  $A$  dimensioning, a substitute length  $L_z = L$  is taken, and for  $L_z$  length the thermal elongation value  $\Delta L$  is determined from Tab. 5. Next, the expansion compensation length  $A$  is determined on the basis of Tab. 6.

## „Z” type compensator

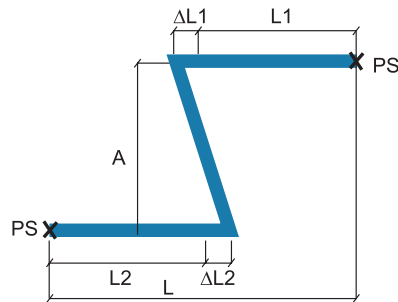

- $A$  – expansion compensation length
- $PS$  – fixed point (prevents the pipeline from moving)
- $L$  – pipeline initial length
- $\Delta L$  – pipeline thermal elongation

For compensation arm  $A$  dimensioning,  $L1$  and  $L2$  sum is taken as a substitute length  $Lz = L1 + L2$ , and for  $Lz$  length a substitute  $\Delta L$  is determined on the basis of Tab. 5. Next, the expansion compensation length  $A$  is determined on the basis of Tab. 6.

## „U” type compensator

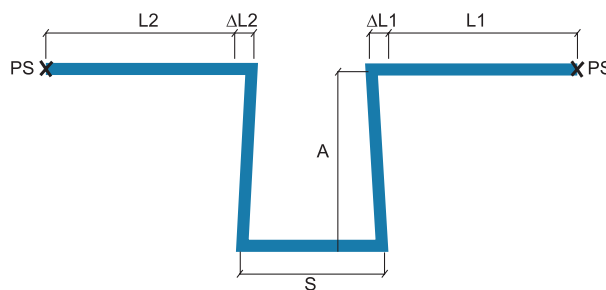

- $A$  – expansion compensation length
- $PS$  – fixed point (prevents the pipeline from moving)
- $L$  – pipeline initial length
- $\Delta L$  – pipeline thermal elongation
- $S$  – U type compensator width

In case of placing fixed point  $PS$  in the section of compensator length  $S$ , for compensation arm  $A$  dimensioning, the greater value from  $L1$  and  $L2$  is taken as a substitute length for  $Lz$ :  $Lz = \max(L1, L2)$  and for this length the substitute elongation  $\Delta L$  is determined on the basis of Tab. 5, and then the length of compensation arm  $A$  is determined on the basis of Tab. 6.

Compensator width:  $S = A/2$ .

**Table: selection of Steel flange connections**

Code	Size	Amount of screws/nuts	Screw size	Screw class	Nut class	Amount of washers	Flange	Flat O-Ring
6341500	35 DN32 PN16	4	M16	8.8	8	8	DN32	DN32 EPDM
6341511	42 DN40 PN16	4	M16	8.8	8	8	DN40	DN40 EPDM
6341522	54 DN50 PN16	4	M16	8.8	8	8	DN50	DN50 EPDM
6303043	64 DN65 PN16	4	M16	8.8	8	8	DN65	DN65 EPDM
6340323	66,7 DN65 PN16	4	M16	8.8	8	8	DN65	DN65 EPDM
620659.6	76,1 DN65 PN16	4	M16	8.8	8	8	DN65	DN65 EPDM
620660.7	88,9 DN80 PN16	8	M16	8.8	8	16	DN80	DN80 EPDM
620661.8	108 DN100 PN16	8	M16	8.8	8	16	DN100	DN100 EPDM